

Integra[®] MicroFrance[®]
Integra Laparoscopy catalogue

Table of contents	ii - iii	Rotatable handles, for \varnothing 5 and 10 mm non-insulated tube	44
Ordering and warranty informations	iv	Angled handle	44
Indications - Contraindications	v	Axial handle	44
MicroFrance® modular Instruments	vi - vii	Ergonomic handle	44
Fenestrated forceps \varnothing 5 mm	2 - 6	Non-insulated tubes	45
Graduated fenestrated forceps \varnothing 5 mm	7	for rotatable instrument \varnothing 5mm	45
Fenestrated forceps \varnothing 10 mm	8 - 9	for rotatable instrument \varnothing 10mm	45
Babcock forceps	10 - 11	Non rotatable axial handles, \varnothing 5 mm and insulated tubes	46
Alligator forceps \varnothing 5 mm	12 - 13	Angled handle	46
Teeth forceps	14 - 16	Axial handle	46
Dissector \varnothing 5 mm	17 - 19	Black insulated tube for non-rotatable instrument	46
Dissector \varnothing 10 mm	20 - 21	Non rotatable ergonomic handles and non insulated tubes	47
Needle-Holder 5 mm	22 - 23	Modular rotatable bipolar forceps	48
Needle-Holder 10 mm	24	Bipolar ergonomic handle	48
Knot Pusher, Knot guide scissors	25	Bipolar insert	48
Scissors \varnothing 5 mm	26 - 28	Protection part	48
Black sheath for metal tube	27	Tubes, \varnothing 5 mm for rotatable bipolar forceps	49
Complete non modular instruments	28	Bipolar cable	49
Insulated scissors insert	27	Insulated tube	49
Metal tube	27	Metal tube and pack of 3 black sheaths	49
Modular instrument	26	Non rotatable bipolar forceps, \varnothing 5 mm	50 - 53
Wire insert	27	Monopolar hook	54
Scissors \varnothing 10 mm	29	Retractable knives, Palpation probe	55
Vascular clamp \varnothing 5 mm	30	Knife blade	55
Vascular clamp \varnothing 12 mm	31	Monopolar cable	55
Vascular clamp \varnothing 10 mm	32 - 33	Monopolar palpation probe	55
Intestinal clamp	34 - 35	Retractable knife	55
Aortic percutaneous clamp	36 - 37	Retractable monopolar electrode	55
Temporary Clamp, Clamp applicator	38	Retractors - Palpation probes	56
Clips applier, Circular suturing holder insert	39	Articulated retractor	56
Rotatable angled handles, \varnothing 5 or 3.5 mm	40	Flat palpation probe	56
Rotatable axial handles, \varnothing 5 or 3.5mm	41	Flexible retractor	56
Rotatable ergonomic handles, \varnothing 5 or 3.5 mm	42	Round palpation probe	56
Tubes, \varnothing 5 mm for rotatable handles, \varnothing 5 or 3.5 mm	43	Flexible tension arm	57
Insulated tube	43	Instrument holder	57
Metal tube and pack of 3 black sheaths	43	Operating table clamp	57
Monopolar cable	43	Electric irrigation suction pump	58
		Cleaning sleeve for telescope	58
		Electric handle for pump	58
		Sterile suction irrigation tube for pump	58
		Suction irrigation tubes for handle	58
		Suction irrigation tube	59
		Handle for modular suction irrigation tube	59
		Modular suction irrigation tube	59
		Non modular suction irrigation tube	59
		Needles - Wire-pass	60

Cholangiography - Choledoscopy	61	Mini invasive instrumentation, 5mm diameter, stylet handle	83
Modular trocars - 3.5 mm	62 - 63	Curved scissors, titanium jaws	83
Composite trocar with silicone valve	63	Forceps with teeth	83
Trocar with metal cannula with magnetic valve	62	Needle-holder, titanium jaws	83
Trocar with metal cannula with silicone valve	62	Needle-holder, tungsten jaws	83
Modular trocars - 5.5 mm	64	Henry set - 3.0mm diameter	84
Modular trocars - 10.5 mm	65	Fenestrated forceps	84
Modular trocar 10.5mm	65	Forceps, alligator jaws	84
Trocar tip palpator probe	65	Monopolar hook	84
Modular trocars - 12/13 mm	66	Round probe	84
Trumpet valve trocars	67	Scissors	84
Spring for Trumpet valve trocars	67	Trocar	84
Trumpet valve trocars	67	Trocar holder ring	84
Automatic valve trocars	68	Terris set	85
Trocar accessories	69	Double retractor	85
Double retractor	69	Elevator	85
Reducer sleeve for trocar	69	Nerve suction with finger control	85
Sealing cap for trocar	69	Peanut holder	85
Thoracic Instrumentation	70	Suction tube elevator	85
Fenestrated forceps	70	Scheye rectal forceps	86
Forceps, curette jaws	70	Axial handle	86
Insert, curette jaws	70	Insert, biopsy jaws and tube 5mm diam	86
Trocar	70	Sterilization case, other accessories	87
Irrigation bipolar forceps	71	Cap	87
3.5mm diameter instrumentation	72 - 76	Plastic sterilization case	87
Adapter cleaning luer-lock	72	Stainless steel sterilization case	87
Bipolar forceps	74	Surgical instrument oil	87
Complete non modular instrument	73	Tray	87
Forceps without port	75	Numerical index	89 - 93
Knot pusher	75	Table for manufacturer part number equivalent	94
Metallic trocar	76	Alphabetical index Global	95 - 98
Modular instrument	72	Alphabetical index Search by name	99 - 101
Monopolar hook	75		
Palpation probe	75		
Suction irrigation tube	75		
Pediatric instrumentation, 3.5mm diameter	77 - 82		
Adapter cleaning luer-lock	80		
Bipolar forceps	79		
Complete non modular instrument	81		
Composite trocar	77		
De Lagausie monopolar instrument	82		
Modular instrument	80		
Monopolar hook	78		
Needle-holder	82		
Retractable knife	78		
Suction irrigation tube	78		

Pricing :

Prices stated in specific written quotations are firm for thirty days from the date given, and are otherwise subject to change without prior notice. Pricing terms stated on written agreements are governed by such agreements.

Minimum Order Requirements :

The minimum ordering amount is €250 (Integra reserves the right to apply €20 handling fees and transport fees for any order below €250). For partial unit orders, please contact the customer service to obtain a quote.

Administrative fees :

Administrative fees may be charged for any order.

Ordering Procedure :

A written purchase order is required for the purchase of Integra MicroFrance® products.

Acceptance of Orders :

Orders are accepted upon approval by Integra Customer Service.

Return Policy :

- Authorization from Customer Service must be obtained prior to returning product.
- Sterile product must be returned in unopened, undamaged cartons, packed to prevent damage.
- Non-sterile product must be returned in unused saleable condition in original package.
- No credit will be issued for special orders.
- A credit note will be issued for products returned less than ninety days from shipment date with a 20% restocking fee, provided that the product being returned is not damaged and it is possible to verify that the product has not been used or opened.

Integra Limited Warranty

Please refer to the warranty included in the packaging of each product to know the applicable warranty.

Contacts Customer service :

International

+33 (0) 4 37 47 59 50
+33 (0) 4 37 47 59 25 (fax)
csemea@integralife.com

France

+33 (0) 4 37 47 59 10
+33 (0) 4 37 47 59 29 (Fax)
custservfrance@integralife.com

Benelux

+32 (0) 2 257 4130
+32 (0) 2 253 2466 (Fax)
custsvcbenelux@integralife.com

United Kingdom

+44 (0) 1264 345 780
+44 (0) 1264 363 782 (Fax)
custsvcs.uk@integralife.com

Germany

+49 (0) 2102 5535 6200
+49 (0) 2102 5536 636 (Fax)
custsvcgermany@integralife.com

Italy

+39 (0) 2 577 8921
+39 (0) 2 575 113 71 (Fax)
custsvcitaly@integralife.com

MicroFrance® Laparoscopy Instrumentation

INDICATIONS

- All the medical devices showed in this catalogue have indications for diagnosis and/or laparoscopy surgery.
- Sizes are not contractual and are given for information purposes only.

CONTRAINDICATIONS







- Do not use in indications other than the indications mentioned in the DFU or Labeling.

How to read this catalogue

Title and/or product family Symbol
"Complete instrument"

"Modular" symbol

Instrument to a 1/1 scale except where mentioned otherwise

Fenestrated forceps # 5 mm			
Modular			Handle
Jaws Scale (x)	Working length		Page #
	Short	Standard	
 Johann 200mm	CEV8625CU 345 mm	CEV8625CU 345 mm	 Rotable 40 -> 45
	CEV8625CU 345 mm	CEV8625CU 345 mm	
	CEV8625CU 345 mm	CEV8625CU 345 mm	
 Concave 200mm	CEV8625CU 345 mm		 Non rotatable 46 - 47
 Bertrand CEV8625CU 345 mm	Bertrand CEV8625CU 345 mm	Bertrand CEV8625CU 345 mm	
 Johann 200mm	CEV8625CU 345 mm "Substandard" design		
 Double-action jaws 200mm	CEV8625DU 345 mm	CEV8625DU 345 mm	

2

DOCUMENT FOR USE IN EUROPE, MIDDLE-EAST AND AFRICA ONLY.

3

DOCUMENT FOR USE IN EUROPE, MIDDLE-EAST AND AFRICA ONLY.

Except contrary indications, pages of this catalogue are presented as below :

- left page : modular instruments
- right page : complete non modular instrument

In the majority of cases, modular instruments are linked to complete instruments. If we don't have any correspondence, you will have an «X» on the line.

Example : CEV8625CU doesn't have complete version.

In the modular inserts table, handles to be used are precised with specific pages. Tubing compatible with handles are mentioned on pages close to handles' pages.

Please refer to modular instruments composition on following page.

MicroFrance® laparoscopic dismantled instruments are composed of three pieces : Jaws, tube and handle..

The black portion of the left tab indicates the section featured in the current page :

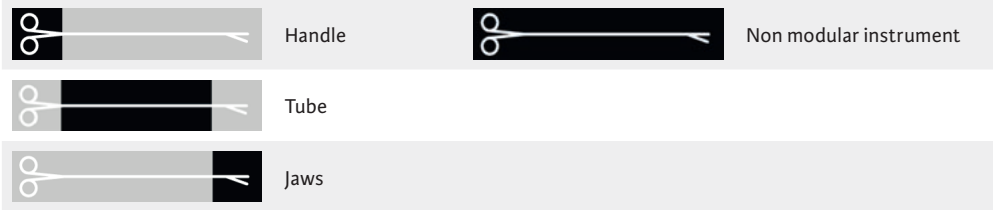

In the majority of cases, modular instruments are linked to complete instruments

Handles

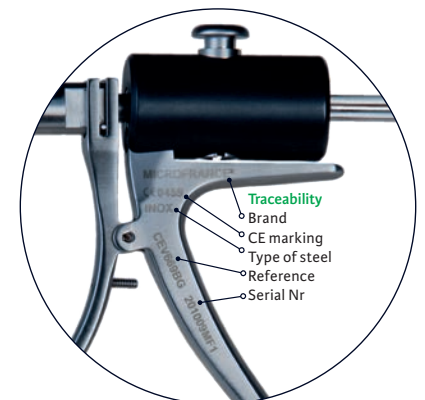
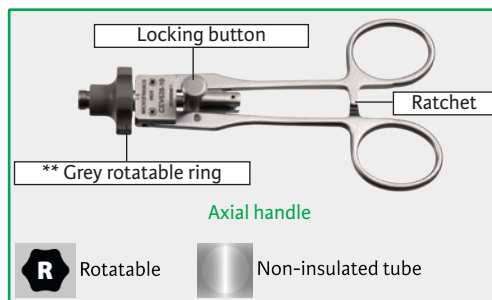
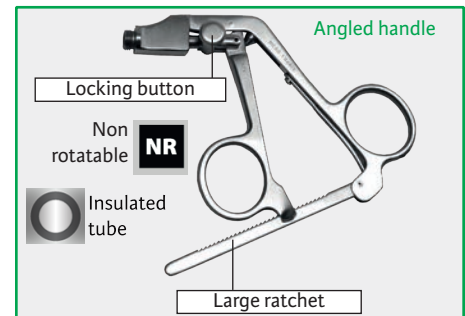
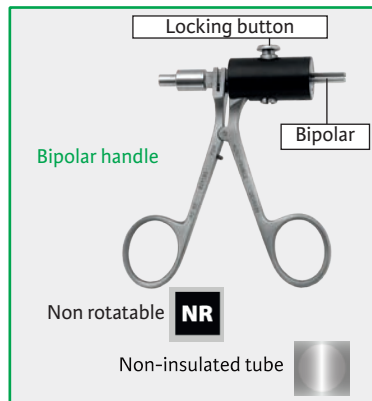
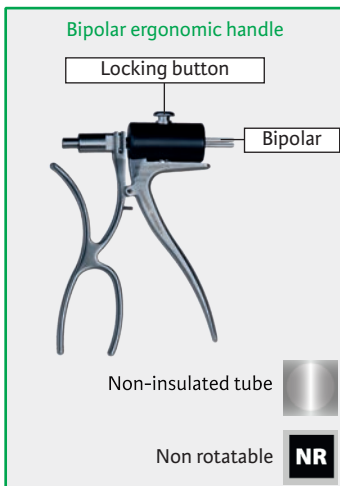
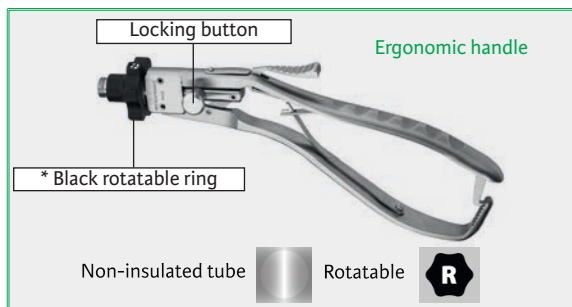
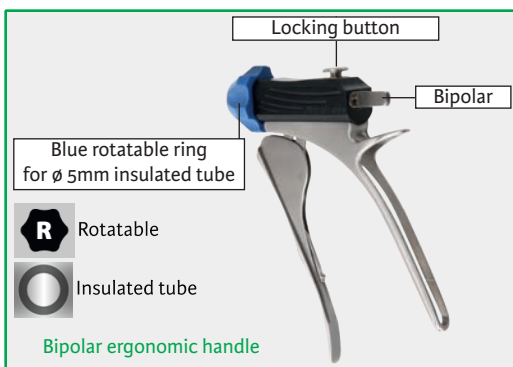

** Grey rotatable ring for metal tube or non insulated tube ø 5mm and 10mm

















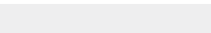

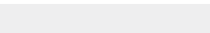
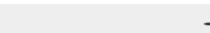

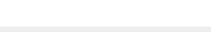

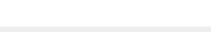
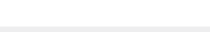
* Black rotatable ring for ø 5mm insulated tube

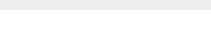
Jaws 

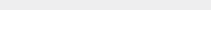

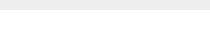
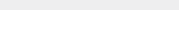

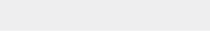

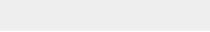
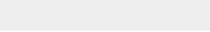
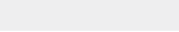
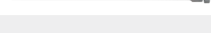
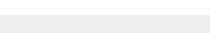
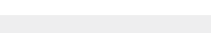
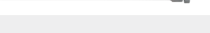
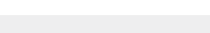
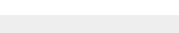





Modular scissors insert : insulated scissors insert blades and wire insert for scissors insert

Tubes 

Non rotatable instrument	Rotatable instrument	Insulated tube	Non insulated tube	Tube with independant sheath	Used for bipolar instrument
					
					
					
					
					
					

























	Modular			
	Inserts			Handle
	Jaws Scale 1/1	Working length		
	Short	Standard	Large	
 Johann 20x5mm	CEV8625T1U 245 mm	CEV625T1U 345 mm	CEV9625T1U 445 mm	 Rotatable 40 -> 45
 Concave 20x5mm	-	CEV670T1U 345 mm	-	Non rotatable 46 - 47 
 Curved jaws 20x5mm	Bertrand CEV8625CU 245 mm	Bertrand CEV625CU 345 mm	Bertrand CEV9625CU 445 mm	
 Johann 20x5mm	-	CEV625P1U 345 mm "Switzerland" design	-	
 Double-action jaws 20x5mm	CEV8625DU 245 mm	CEV625DU 345 mm	CEV9625DU 445 mm	

NON Modular

Complete instruments





















Jaws Scale 1/1	Handle	Working length	
		Short	Standard
 Johann 20x5mm	 With ratchet		Johann CEV405U 365 mm
	 With spring	–	Gayet CEV405BG 365 mm
	 With ratchet		Montupet CEV815 240 mm
	 With ratchet	CEV915G 240 mm	CEV525 345 mm
	 With long ratchet	–	CEV725 345 mm
 Concave 20x5mm	 With ratchet	–	CEV470U 365 mm
 Curved jaws 20x5mm	 With ratchet	–	Bertrand CEV525C 345 mm

	Modular				
	Inserts			Handle	
	Jaws Scale 1/1	Working length			
	Short	Standard	Large		
 15x5mm	-	CEV4o6IU 340 mm	-		
 Desmaizieres 20x3mm	CEV84o7IU 245 mm	CEV4o7IU 345 mm	CEV94o7IU 445mm	  	
 40x5mm	CEV866oT1U 270 mm	CEV66oT1U 370 mm	CEV966oT1U 470 mm		
 Concave 40x5mm	-	CEV671T1U 370 mm	-	Rotatable 40 -> 45 Non rotatable 46 - 47	
 Crovella 40x5mm smooth jaws	-	CEV661IU 370 mm	-	 	
 Crovella 30x5mm smooth jaws	-	CEV662IU 335mm	-		

NON Modular



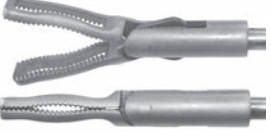



Complete instruments







Jaws Scale 1/1	Handle	Working length	
		Standard	
 15x5mm	 With ratchet	CEV406U 360mm	
 Desmaizieres 20x3mm	 With ratchet	Desmaizieres CEV407U 365mm	
 40x5mm	 With ratchet	Desplantez CEV460U 385mm	
	 Axial, with long ratchet	CEV760 365mm	
 Concave 40x5mm	 With ratchet	CEV470T1U 385mm	

	Modular				Page #	
	Inserts			Working length		Handle
	Jaws Scale 1/1	Short	Standard			
 <p>Round double-action jaws 15x5mm</p>	—	CEV433DU 350 mm	—			
 <p>Smooth jaws 20x5mm</p>	CEV8625EU 245 mm	CEV625EU 345 mm	—	  		
 <p>Porpiglia one fenestrated jaws 20x5mm</p>	—	CEV625PU 345 mm	—	<p>Rotatable 40 -> 45</p> <p>Non rotatable 46 - 47</p>		
 <p>Concave double-action jaws 15x5mm</p>	CEV8670DU 240 mm	CEV670DU 340 mm	CEV9670DU 440 mm	 		



Modular











Inserts		Handle
Jaws Scale 1/1		Page #
 <p>De Manzini CEV7625I 435 mm - 20x5mm</p>	 <p>Scopinaro CEV7660I 435 mm - 40x5mm</p>	
Tubes Scale 1/3		
<p>CEV649M5</p>  <p>Graduation 50 / 100 / 150 mm</p>	<p>CEV649G5</p>  <p>Graduation 100 / 150 / 200 mm</p>	 <p>Rotatable 44 - 45</p> 





	Modular		
	Inserts		Handle
	Jaws Scale 1/1	Working length	Page #
 Round jaws, Double-action jaws	CEV433-1 370 mm	 Rotatable 44 -> 45 	
 35x10mm	CEV610-1 375 mm		
 Hüscher Round jaws, Double-action jaws	CEV433H 380 mm		
 Round jaws, Double-action jaws with tube CEV864910B (see page 47)	CEV8434I 295 mm Short		

NON Modular





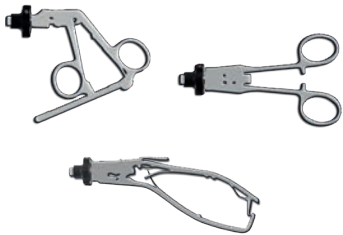

Complete instruments

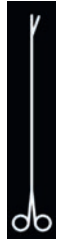













Jaws Scale 1/1	Handle	Working length
 Round jaws, Double-action jaws	 Axial, with ratchet	CEV533-2 370 mm
 35x10mm	 Angled, with long ratchet	CEV410 360 mm
	 Axial, with ratchet	CEV530 370 mm
 Duval	 Angled, with long ratchet	CEV432 365 mm
	 Axial, with ratchet	CEV507 375 mm
 Round jaws	 Angled, with long ratchet	CEV433 365 mm

Modular		
Inserts		Handle
Jaws Scale 1/1	Working length	
		Page #
 Ø10mm	Delaitre CEV602-1 370 mm	
		 Rotatable 44 - 45 
		 Rotatable 40 -> 45 Non rotatable 46 - 47 
 Delaitre Ø5mm	Short Standard CEV8621T1U 250 mm CEV621T1U 350 mm	















NON Modular						
Complete instruments						
Jaws Scale 1/1	Handle	Working length				
 Ø10mm	 Angled, with long ratchet	Delaitre CEV420 360 mm				
	 Axial with ratchet	Delaitre CEV502 370 mm				
 Ø5mm	 Angled, with long ratchet	<table border="0"> <tr> <td>Short</td> <td>Standard</td> </tr> <tr> <td> Montupet CEV821G 245 mm </td> <td> Delaitre CEV421 370 mm </td> </tr> </table>	Short	Standard	Montupet CEV821G 245 mm	Delaitre CEV421 370 mm
	Short	Standard				
	Montupet CEV821G 245 mm	Delaitre CEV421 370 mm				
 Axial, with ratchet	— Delaitre CEV521 350 mm					
 Axial with long ratchet	— CEV721 350 mm					

	Modular				
	Inserts			Handle	
	Jaws Scale 1/1	Working length			
	Short	Standard	Large		
 Manhès 10mm	—	CEV614T1U 335 mm	CEV9614T1U 435 mm		
 Manhès 15mm	CEV8615T1U 240 mm	CEV615T1U 340 mm	CEV9615T1U 440 mm	  	
 Manhès 20mm	—	CEV620T1U 345 mm	CEV9620T1U 445 mm	Rotatable 40 -> 45 Non rotatable 46 - 47 	
 Dauphin 20x3mm	—	CEV617IU 340 mm	CEV9617IU 440 mm		
 Serrated jaws inserts, 15x5mm	CEV8624IU 240 mm	CEV624IU 340 mm	CEV9624IU 440 mm		

NON Modular

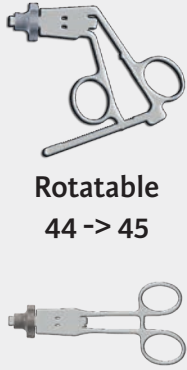











Complete instruments







Jaws Scale 1/1	Handle	Working length	
		Standard	
 10mm	 With ratchet	Manhès CM110U 355 mm	
 15mm	 With ratchet	Manhès CM115U 360 mm	
	 Axial, with ratchet	CEV515 340 mm	
 20mm	 With spring	Manhès CEV220U 365 mm	
	 With ratchet	Manhès CM120U 365 mm	

		Modular				
		Inserts			Handle	
Jaws Scale 1/1		Working length			Page #	
 Ø10mm Grasping insert		Claw CEV606-1 370 mm			 Rotatable 44 -> 45	
		Short	Standard	Large		
		 Allis Grasping insert Ø5mm		CEV8611T1U 235 mm		
 Manhès Cobra Ø5mm		-	Manhès CEV612T1U 340 mm	-	Rotatable 40 -> 45 Non rotatable 46 - 47	
 Manhès Tiger Ø5mm		CEV8613T1U 240 mm	Manhès CEV613T1U 340 mm	-		

NON Modular









Complete instruments









Jaws Scale 1/1	Handle	Working length
		Standard
 Ø10mm	 Angled with spring	Claw CEV321 360 mm
	 Axial, with ratchet	Claw CEV506 370 mm
 Allis Grasping forceps Ø5mm	 With spring	Allis CEV211U 355 mm
	 With ratchet	Allis CM111U 355 mm
	 Axial, with ratchet	Allis CEV511 335 mm
 Manhès Cobra Ø5mm	 With ratchet	Manhès CM112U 355 mm
	 Axial, with ratchet	Manhès CEV512 335 mm
 Manhès Tiger Ø5mm	 With ratchet	Manhès CM113U 360 mm

Modular				
Inserts			Handle	
Jaws Scale 1/1	Working length			Page #
	Short	Standard	Large	
 cobra Double-action jaws Ø5mm	CEV8612DU 240 mm	CEV612DU 340 mm	CEV9612DU 440 mm	   Rotatable 40 -> 45
 Vallancien Fenestrated jaws insert with teeth Ø5mm 20x5mm	CEV8616IU 245 mm	CEV616IU 345 mm	—	Non rotatable 46 - 47  



Modular







Inserts		Handle
Jaws Scale 1/1	Working length	Page #
 <p>Delaitre Double-action jaws, 22mm Ø5mm</p>	<p>CEV641DU 355 mm</p>	  <p>Rotatable 40 -> 45</p> <p>Non rotatable 46 - 47</p>  
 <p>Double-action jaws, 20mm Ø5mm</p>	<p>CEV641FU 350 mm</p>	
 <p>Allal Double-action jaws 15mm Ø5mm</p>	<p>CEV642TFU 345 mm</p>	
 <p>Double-action jaws, angled 20mm jaws 90deg Ø 5mm</p>	<p>CEV643IU 345 mm</p>	







	Modular			
	Inserts			Handle
	Jaws Scale 1/1	Working length		
	Short	Standard	Large	
 Short curved Double-action jaws, 12mm	-	CEV532IU 335 mm	-	  Rotatable 40 -> 45 Non rotatable 46 - 47
 Medium curved Double-action jaws, 15mm	CEV8641T1U 245 mm	CEV641T1U 345 mm	CEV9641T1U 445 mm	
 Long curved Double-action jaws, 18mm	CEV8642T1U 245 mm	CEV642T1U 345 mm	CEV9642T1U 445 mm	 

NON Modular

Complete instruments







Jaws Scale 1/1	Handle	Working length
 <p>Short curved Double-action jaws, 12mm</p>	 <p>Axial, with ratchet</p>	<p>CEV532 340 mm</p>
 <p>Medium curved Double-action jaws, 15mm</p>	 <p>Axial, with ratchet</p>	<p>CEV531-2 340 mm</p>
 <p>Long curved Double-action jaws, 18mm</p>	 <p>Axial, with ratchet</p>	<p>CEV531T3U 350 mm</p>











	Modular		
	Inserts		Handle
	Jaws Scale 1/1	Working length	Page #
 Delaitre Medium curved 50mm	CEV601-1 380 mm		
 Delaitre Medium curved - Double-action jaws, 50mm	CEV651-1 380 mm	 	
 Pignata Short curved 90deg, 45mm	CEV601P 380 mm	Rotatable 44 -> 45	
 Puglisi Long curved Double-action jaws, 60mm	CEV6521 380 mm		

NON Modular

Complete instruments

























Jaws Scale 1/1	Handle	Working length
 <p>Medium curved 50mm</p>	 <p>Angled</p>	<p>Delaitre CEV430 370 mm</p>
	 <p>Axial, with ratchet</p>	<p>Nouaille CEV501 380 mm</p>
 <p>Delaitre Medium curved - Double-action jaws, 50mm</p>	 <p>Axial, with ratchet</p>	<p>CEV501-2 380 mm</p>

	Modular				Page #	
	Inserts			Working length		Handle
	Jaws Scale 1/1	Short	Standard			
 Tungsten straight jaws	-	CEV500TU 335 mm	CEV9500TU 435 mm		   Rotatable 40 -> 45 Non rotatable 46 - 47  	
 Tungsten curved left jaws	CEV8538TU 240 mm	CEV538TU 340 mm	-			
 Tungsten curved right jaws	CEV8544IU 240 mm	CEV544IU 340 mm	CEV9544IU 440 mm			
 Titanium automatic jaws	CEV8650TU 235 mm	CEV650TU 335 mm	CEV9650TU 435 mm			

NON Modular







Complete instruments

Jaws Scale 1/1	Handle	Working length		
		Short	Standard	Large
 Tungsten straight jaws	 Axial, with ratchet	CEV965 230 mm	CEV500T5 335 mm	–
	 Large ergonomic handle with ratchet up	–	CEV700T5 335 mm	–
	 Large ergonomic handle with ratchet up	–	CEV700T5D 335 mm	CEV9700T5D 450 mm
 Tungsten curved left jaws	 Axial, with ratchet	–	CEV538T5 335 mm	–
	 Large ergonomic handle with ratchet up	–	CEV738T5 335 mm	CEV9738T5 455 mm
	 Fine ergonomic handle	–	CEV738-5 350 mm	–
	 Fine ergonomic handle	–	CEV738D5 350 mm	–
 Tungsten curved right jaws	 Axial, with ratchet	–	CEV544 335 mm	–
	 Large ergonomic handle with ratchet up	–	CEV744T5 335 mm	CEV9744T5 455 mm
 Titanium automatic jaws	 Axial, with ratchet	–	Mouiel CEV540-5 335 mm	–
	 Large ergonomic handle with ratchet up	–	CEV650T5D 335 mm	–
	 Fine ergonomic handle	–	CEV740-5 350 mm	–







NON Modular			
Complete instruments			
Jaws Scale 1/1	Handle		Working length
 <p>Nouaille Straight jaws</p>	 <p>Axial, with ratchet</p>	<p>Nouaille CEV500-A10 345 mm</p>	
 <p>Left curved jaws</p>	 <p>Axial, with ratchet</p>	<p>CEV538-10 345 mm</p>	
 <p>Straight automatic jaws</p>	 <p>Axial, with ratchet</p>	<p>Mouiel CEV540-10 345 mm</p>	
	 <p>Fine ergonomic handle</p>	<p>CEV640-10 340 mm</p>	





















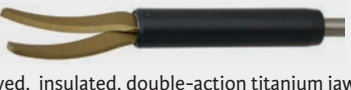

Knot Pusher - 5 mm

		NON Modular	
		Complete instruments	
	Delaitre CEV442 L 340 mm		Working length «L» Scale 1/3
	CEV442E L 300 mm		
	CEV442Z L 350 mm		









Knot guide scissors - 5 mm

		NON Modular				
		Complete instruments				
	Jaws Scale 1/1	Handle		Working length		
				Short	Standard	Large
 <p>Drouard Complete non modular instrument</p>	 <p>Angled handle</p>	-	CEV445-5 355 mm	-		
 <p>Drouard Modular instrument</p>	 <p>Rotatable 40 -> 45</p>	 <p>Non rotatable 46 - 47</p>	CEV8445IU 235 mm	CEV445IU 335 mm	CEV9445IU 435 mm	

	Modular			
	Inserts			Handle
	Blades Scale 1/1	Working length		
	Short	Standard	Large	
 Straight, serrated blades 10mm	CEV8104IU 240 mm	CEV104IU 340 mm	CEV9104IU 440 mm	
 Straight, Double-action jaws, 10mm	CEV8623T1U 240 mm	CEV623T1U 340 mm	CEV9623T1U 440 mm	
 Curved, Double-action jaws, 15mm	CEV8605T1U 245 mm	CEV605T1U 345 mm Pack 1 CEV605T3U 345 mm Pack 3	CEV9605T1U 445 mm	  Rotatable 40 -> 45
 Curved, double-action jaws, 15mm with insulated tube delivered with CEV39L (see page 72)	—	CEV605T5U 345 mm Pack 3	—	Non rotatable 46 - 47
 Curved, insulated, double-action jaws, 15mm	CEV8605GU 250 mm Pack 3	CEV605GU 350 mm Pack 3	CEV9605GU 450 mm Pack 3	 
 Curved, insulated, double-action titanium jaws, 15mm	CEV8605GTU 250 mm	CEV605GTU 350 mm	CEV9605GTU 450 mm	
 Curved, Double-action jaws, 10mm	CEV8604T1U 240 mm	CEV604T1U 340 mm Pack 1 CEV604T3U 340 mm Pack 3	CEV9604T1U 440 mm	



	Modular						
	Insulated insert	Wire insert			Handle		
		Working length - Scale 1/6					
Double-action jaws for wire insert Scale 1/1	245 mm	345 mm	445 mm	Page #			
 <p>CEV607U Curved, Metzenbaum type, 15 mm - Pack 6</p>				  Rotatable 40 -> 45			
 <p>CEV607CU Curved blades, 10mm - Pack 6</p>							
 <p>CEV607DU Straight blades, 10mm - Pack 6</p>							
	Wire insert without insulated sheath - single						
	CEV8607T1U	CEV607T1U	CEV9607T1U				
 <p>Curved, Metzenbaum type</p> <p>CEV605BGPU single</p> <p>CEV605GPU Pack 3</p>				Non rotatable 46 - 47  			
	Metal tube and black sheath						
à l'unité	CEV8649BGPU	CEV649BGPU	CEV9649BGPU				
Pack 3	CEV8649GPU	CEV649GPU	CEV9649GPU				
	Black sheath for metal tube - Pack 3						
	CEV8649C5U	CEV649C5U	CEV9649C5U				

Nota:
For cleaning, the insert and the wire insert must be disassembled.



NON Modular				
Complete instruments				
Jaws Scale 1/1	Handle	Working length		
		Short	Standard	
 Straight scissors, serrated blades, 10mm	 Angled	Montupet CEV804 235 mm	Manhès CM104 355 mm	
	 Axial	CEV904 235 mm	-	
 Straight scissors delicate serrated blades, 10mm	 Angled	-	Manhès CM106 355 mm	
 Curved scissors, Serrated blades, 10mm	 Angled	-	CEV114MU 355 mm	
	 Axial	-	CEV514MU 335 mm	



NON Modular



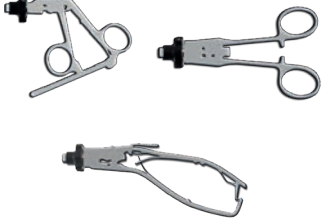

Complete instruments

Jaws Scale 1/1	Handle	Working length
 <p>Curved scissors Serrated blades, 25 mm</p>	 <p>Angled</p>	<p>CEV404 340 mm</p>
	 <p>Axial</p>	<p>CEV503 350 mm</p>

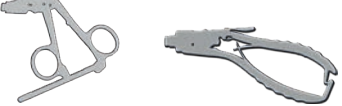
Modular



 <p>Curved scissors, serrated blades, Double-action jaws 25 mm</p>	 <p>Rotatable 44 -> 45</p>	<p>CEV653-1 365 mm</p>
---	--	-----------------------------------





Modular				
Inserts			Handle	
Jaws Scale 1/1	Working length			Page #
	Short	Standard	Large	
 Straight clamp insert 25mm jaws	CEV8626I 250 mm	CEV626-1 350 mm	-	 Rotatable 40 -> 45
 Curved clamp insert Double-action jaws 25mm jaws	CEV8627I 255 mm	CEV627I 355 mm	CEV9627I 455 mm	Non rotatable 46 - 47 

NON Modular		
Complete instruments		
Jaws Scale 1/1	Handle	Working length
		Standard
 Debakey Straight clamp 20mm jaws	 Axial, with ratchet	Debakey CEV526 350 mm
 Desmaizieres Straight clamp 20mm jaws	 Angled, with long ratchet	Desmaizieres CEV527 365 mm

NON Modular









Complete instruments





	Jaws Scale 1/1	Handle	Working length
	 <p>Dulucq Left curved, 60mm jaws</p>	 <p>Axial, with ratchet</p>	<p>Dulucq CEV570 400 mm</p>

	Modular		
	Inserts		Handle
	Jaws Scale 1/1	Working length	Page #
 <p>Delaitre Left curved, 45mm jaws</p>	<p>CEV635-1 385 mm</p>	 <p>Rotatable 44 -> 45</p> 	

NON Modular

Complete instruments

Jaws Scale 1/1	Handle	Working length
 <p>Querleu Left curved, 45mm jaws</p>	 <p>Angled with long ratchet</p>	<p>Querleu CEV435-1 375 mm</p>
 <p>Delaitre Left curved, 45mm jaws</p>	 <p>Axial, with ratchet with safety lock</p>	<p>Querleu CEV535 385 mm</p>
 <p>Querleu Right curved, 45mm jaws</p>	 <p>Angled with long ratchet</p>	<p>Delaitre CEV505 385 mm</p>
 <p>Curved jaws 75mm jaws</p>	 <p>Axial, with ratchet with safety lock</p>	<p>Querleu CEV435-2 375 mm</p>
		<p>CEVA112 320 mm</p>



Modular			
Inserts		Handle	
Jaws Scale 1/1	Working length	Page #	
 <p style="text-align: center;">Straight clamp insert 65x7mm jaws Ø 10mm</p>	<p>CEV608-1 400 mm</p>		
 <p style="text-align: center;">Annibale Straight clamp insert Double-action jaws 65x7mm jaws Ø 10mm</p>	<p>Annibale CEV608D 400 mm</p>	<p>Rotatable 44 - 45</p> 	









NON Modular

Complete instruments



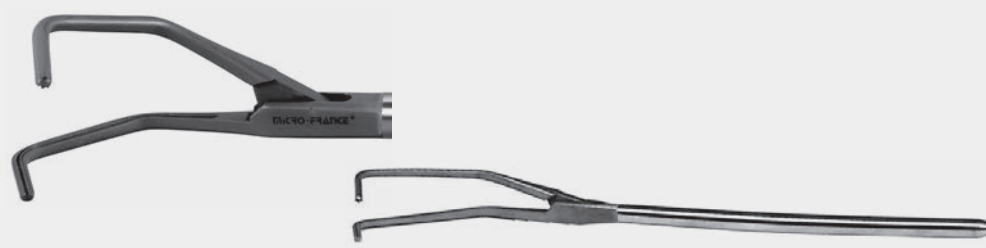

Jaws Scale 1/1	Handle	Working length
	 <p>Angled with long ratchet</p>	<p>Delaitre CEV431-65 390 mm</p>
<p>Straight clamp, 65x7mm jaws Ø 10mm</p>	 <p>Axial, with ratchet with safety lock</p>	<p>CEV508 400 mm</p>



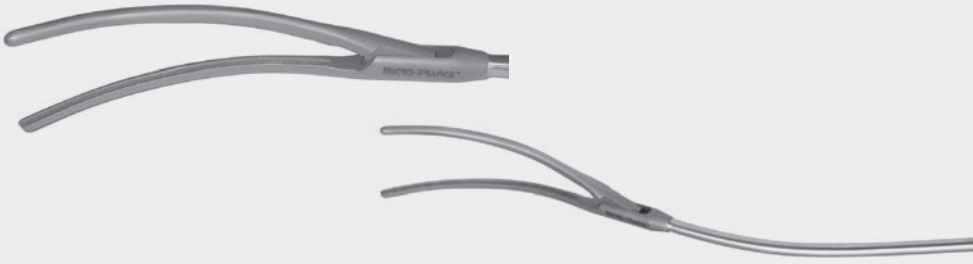

NON Modular			
Complete instruments			
Scale 1/1	Jaws	Handle	Reference
  <p>Satinsky Angled clamp, curved tube, working length 260 mm, 110 mm jaws</p>			CEVA101
 <p>Angled clamp, curved tube, working length 250 mm, 90 mm jaws</p>		 <p>Axial, with ratchet with safety lock</p>	CEVA102
 <p>Satinsky Angled clamp, curved tube, working length 240 mm, 80 mm jaws</p>			CEVA103
 <p>Angled clamp, curved tube, working length 290 mm, 110 mm jaws</p>			CEVA104 290 mm

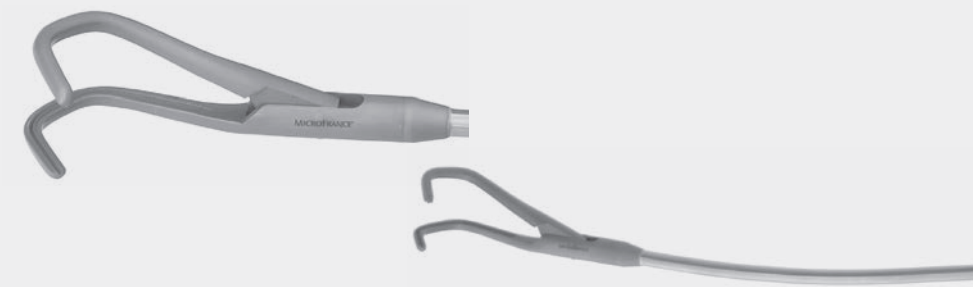
NON Modular



Complete instruments



Scale 1/1	Jaws	Handle	Working length
	 <p>Desmaizieres Angled clamp, curved tube, working length 270 mm, 85 mm jaws</p>		CEVA110
	 <p>Desmaizieres Angled clamp, curved tube, working length 270 mm, 90 mm jaws</p>	 <p>Axial, with ratchet with safety lock</p>	CEVA528
	 <p>Desmaizieres Angled clamp, curved tube, working length 220 mm, 60 mm jaws</p>		CEVA529

Temporary Clamps

 <p>CEV565 + CEV560</p>		
<p>Jaws Scale 1/1</p>		
	<p>Straight vascular clamp 15x3mm Pack 2</p>	<p>Sartori CEV568</p>
	<p>Straight vascular clamp 25x3mm Pack 2</p>	<p>Begin CEV565</p>
	<p>Choledoque clamp 35x4mm Pack 2</p>	<p>Begin CEV566</p>
	<p>Intestinal clamp 45x5mm Pack 2</p>	<p>Begin CEV567</p>

Clamp applicator, Ø 10 mm



NON Modular			
Jaws Scale 1/1	Handle		Working length
  <p>Clamp applicator 360mm</p>		<p>Axial, with ratchet</p>	<p>Begin CEV560</p>

Modular		
  <p>Clamp applicator insert for tube Ø10mm 310mm</p>	 <p>Rotatable 44 -> 45</p>	<p>CEV560-1 355 mm</p>

Clips applier







NON Modular









Complete instruments

	NON Modular		
	Complete instruments		
Jaws Scale 1/1	Handle		Working length
 Clip applier for T1300 et LC300 clips Ø 10mm		Angled with spring	CEV310 335 mm

Circular suturing holder insert

Modular

	Modular		
	 Morino Circular suturing holder insert Double-action jaws Ø 10mm	 Rotatable 44 -> 45	Morino CEV603I 375 mm
 Massard Circular suturing holder insert Ø 5mm	 Rotatable 40 -> 45 Non rotatable 46 - 47 	Massard CEV622IU 335 mm	

Modular			
Rotatable Instruments			
Angled handles with black rotatable ring Scale 1/3			
 with ratchet	CEV1019T5BU Large pattern	 with ratchet	CEV10195CU
 with ratchet	CEV10195DU	 with ratchet	CEV10195RU
 without ratchet	CEV1039T5TBU Large pattern	 without ratchet	CEV10395DU
 without ratchet	CEV10395RU	 Insulated handle without ratchet	CEV1039G5U

Tube for angled handles, 5 et 3.5mm
see page 43

Modular

Rotatable Instruments

Axial handles with black rotatable ring
Scale 1/3



CEV6285R

with ratchet



CEV628P5

with ratchet



CEV6385RU





without ratchet



CEV728T5

with long ratchet





Tube for rotatable axial handles, 5 et 3.5mm
see page 43

Modular	
Rotatable Instruments	
Ergonomic handles with black rotatable ring Scale 1/3	
 Large ergonomic handle with ratchet CEV720BRUC	 Fine ergonomic handle with ratchet CEV720RU
 Elhadad Fine ergonomic handle with ratchet CEV7285RU	 Large ergonomic handle with ratchet CEV728BR5U

Tube for rotatable ergonomic handles, 5 et 3.5mm
see page 43

Insulated tubes - 5 mm



Modular		
Rotatable instruments		
Working length		
Short 210mm	Standard 310 mm	Long 410mm
		
Black insulated tube		
CEV8649T5TBU	CEV649T5BU	CEV9649T5TBU
		
Yellow insulated tube		
CEV8646B5U	CEV646B5U	CEV9646B5U
		
Blue insulated tube		
CEV8647B5U	CEV647B5U	CEV9647B5U
		
Green insulated tube		
CEV8648B5U	CEV648B5U	CEV9648B5U

Metal tube and Pack of 3 black sheaths









		
Metal tube 5mm diameter for black sheath		
CEV8649B5U	CEV649B5U	CEV9649B5U
		
Black sheath 5mm diameter for tube Pack 3		
CEV8649C5U	CEV649C5U	CEV9649C5U



Modular

Rotatable Instruments

Handles with grey rotatable ring
Scale 1/3

 <p>Angled handle with long ratchet</p>	 <p>Angled handle without ratchet</p>
 <p>Axial handle with ratchet</p>	 <p>Axial handle without ratchet</p>
 <p>Fine ergonomic handle with ratchet</p>	 <p>Large ergonomic handle with ratchet</p>
 <p>Axial handle with long ratchet</p>	<p>Tube for rotatable handles for \varnothing 5 and 10 mm non-insulated tube see page 45</p>



Modular

Rotatable instruments

Working length

Short

Standard

Large



Non-insulated tube for rotatable instrument \varnothing 10mm

CEV864910B
215mm

CEV649-10B
305mm

–







Non-insulated tube for rotatable instrument \varnothing 5mm

CEV8649X5
210mm

CEV649X5
310mm

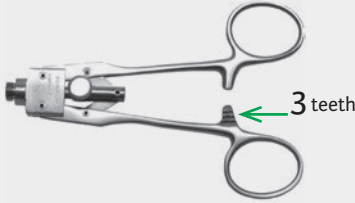
CEV9649X5
410mm

Non Rotatable handles - 5 mm - for black insulated tube

Modular	
Non rotatable Instruments	
Handles without rotatable ring Scale 1/3	
 Angled handle with long ratchet CEV1019T5NUC	 Axial handle with ratchet CEV628-5N
 Angled handle with long ratchet CEV10195NAU	 Axial handle without ratchet CEV638T5NU
 Angled handle without ratchet CEV1039T5NU	

Black insulated tube for non-rotatable instrument \varnothing 5mm

 Black insulated tube for non-rotatable instrument \varnothing 5mm		
Working length		
Short 210mm	Standard 310mm	Large 410mm
CEV8649T5NU	CEV649T5NU	CEV9649T5NU

Non Rotatable handles - 5 mm - for non-insulated tube

Modular

Non rotatable instruments

Handles without rotatable ring
Scale 1/3













 <p>CEV720</p> <p>Fine ergonomic handle with on/off ratchet</p>	 <p>CEV720B</p> <p>Large ergonomic handle with on/off ratchet</p>
--	---

Non-insulated tube for non-rotatable instrument ø 5mm



 <p>Non-insulated tube for non-rotatable instrument ø 5mm</p>		
<p>Working length</p>		
<p>Short 210mm</p>	<p>Standard 310mm</p>	<p>Large 410mm</p>
<p>CEV8649P5</p>	<p>CEV649P5</p>	<p>CEV9649P5</p>





Modular					
Inserts					Handle
Jaws Scale 1/1		Working length			
		Short	Standard	Large	
	Allis Grasping forceps 10x4mm	CEV8611H 235 mm	CEV611H 335 mm	CEV9611H 435 mm	 CEV669E Large ergonomic handle bipolar without ratchet with blue rotatable ring for insulated tube Ø 5mm
	Manhès Cobra 15x4mm	CEV8612LH 245 mm	CEV612LH 345 mm	CEV9612LH 445 mm	
	Alligator 15x4mm	CEV8615H 240 mm	CEV615H 340 mm	CEV9615H 440 mm	
	Johann 20x5mm	CEV8625H 245 mm	CEV625H 345 mm	CEV9625H 445 mm	
	Botella Triangle fenestrated jaws 20x4mm	CEV8633H 245 mm	CEV633H 345 mm	CEV9633H 445 mm	
	Dissector curved left 18x4mm	CEV8642H 245 mm	CEV642H 345 mm	CEV9642H 445 mm	
	Dissector curved right 18x4mm	CEV8642HD 245 mm	CEV642HD 345 mm	CEV9642HD 445 mm	



CEV600H
Protection part
for tip jaws Bipolar
Delivered with bipolar insert
For cleaning and sterilizing

Tube Ø 5mm for modular rotatable bipolar forceps
or bipolar instrument
see page 49

Insulated tubes - 5 mm

Modular			
Rotatable instruments			
Working length			
Short 210mm	Standard 310 mm	Large 410mm	
 <p>Black insulated tube</p>			
CEV8649T5TBU	CEV649T5BU	CEV9649T5TBU	
 <p>Yellow insulated tube</p>			
CEV8646B5U	CEV646B5U	CEV9646B5U	
 <p>Blue insulated tube</p>			
CEV8647B5U	CEV647B5U	CEV9647B5U	
 <p>Green insulated tube</p>			
CEV8648B5U	CEV648B5U	CEV9648B5U	

Metal tube and Pack of 3 black sheaths

 <p>Metal tube 5mm diameter for black sheath</p>			
CEV8649B5U	CEV649B5U	CEV9649B5U	
 <p>Black sheath 5mm diameter for tube Pack 3</p>			
CEV8649C5U	CEV649C5U	CEV9649C5U	

Bipolar cables 4.5 m



CP393-2

Bowa Emc Lamidey Valleylab













CP393-3

Erbe VIO ICC ACC
(except international)
Storz Wolf



CP393-4









Aesculap Berchtold Martin
Sutter BM 780 II

Modular								Handles Non rotatable
Inserts & Tubes								
Jaws Scale 1/1	Working length							
	Short		Standard		Large			
	Insert	Tube 1/3	Insert	Tube 1/3	Insert	Tube 1/3		
	 Mouiel 15x5mm	CEV86341A 245 mm		CEV634-1A 340 mm		CEV9634-1A 430 mm	 CEV669B Angled handle	
	 with hook 15x5mm	-		CEV632-1A 340 mm		CEV96321A 430 mm	 CEV669BG Gayet Ergonomic handle	
	 Gayet 20x5mm	CEV86361A 250 mm		CEV636-1A 345 mm		CEV96361A 435 mm	 MCEN54P Dessi Angled handle	
	 Vallancien with teeth 20x5mm	-		CEV637I 345 mm		-	 CEV86795B 210 mm	 CEV6795B 310 mm







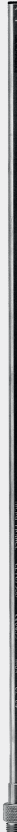

NON Modular

Complete instruments

Jaws Scale 1/1	Handle		Working length		
			Short	Standard	Large
 15x5mm	 Angled	CEV834 240 mm	Mouiel CEV134 360 mm	–	
	 Ergonomic with graduated tube 100mm	–	Gayet CEV134BG 360 mm	Gayet CEV9134BG 450 mm	
	 Axial	–	CEV580-2 365 mm	–	
 15x5mm with hook	 Angled	–	CEV132 360 mm	–	
 Gayet 20x5mm	 Angled	–	Gayet CEV136 365 mm	–	











Modular					
Inserts & Tubes					Handles Non rotatable
Jaws Scale 1/1	Working length				
	Standard		Large		
	Mors	Tube 1/3	Mors	Tube 1/3	
 Manhès Spatula jaws 10x3mm	CEV630-1A 340 mm		CEV9630-1A 425 mm		 CEV669B Angled handle
 Botella Triangle fenestrated jaws 12x5mm	CEV633-1A 340 mm		CEV96331A 430 mm		 Gayet CEV669BG Ergonomic handle
 Spatula angled jaws 10x2mm	CEV630C 340 mm		-		 MCEN54P Dessi Angled handle
		CEV6795B 310 mm		CEV96795B 395 mm	



NON Modular

Complete instruments



Jaws Scale 1/2	Handle	Working length	
		Short	Standard
 Spatula jaws 10x3mm	 Angled	Montupet CEV830 240 mm	Manhès CEV130 360 mm
 Botella Triangle fenestrated jaws 12x5mm	 Angled	—	Botella CEV133 360 mm
	 Axial	—	Botella CEV580-3 360 mm
—	—	—	—
 Delicate triangular jaws 8x5mm	 Angled	—	Botella CEV133-1 360 mm
 Manhès 10x2mm	 Angled	—	Manhès CM131 360 mm



		Modular			
		Hook jaws Scale 1/1			
	CEV229-2A Crochet # 2 Pack 3	CEV229-3A Crochet # 3 Pack 3	CEV229-4A Crochet # 4 Pack 3	CEV2295A Crochet # 5 Pack 3	
	Manche de crochet Scale 1/3				
	CEV225A	Working length 430mm			
CEV82291	Working length 230mm				
CEV229-1A	Working length 350mm				
CEV9229-1	Working length 450mm				
CEV229B	Working length 380mm				







		Monopolar hook, non modular		
		Scale 1/3		
	1/1		CEV225	Working length 430mm
1/1		PÉRISSAT CEV230-1	Working length 330mm	
1/1		MONTUPET CEV825	Working length 220mm	



Retractable knife, monopolar electrode

NON Modular

Complete instruments

	1/3			
	1/1		CEV135-5	Retractable knife ø 5mm 300mm without knife blades SM63 / SM64 / SM65
	1/3			
	1/1		CM109 Manhès	Retractable monopolar electrode ø 5mm 320mm

Monopolar palpation probe

	1/3			
	1/1		CEV443 Delaitre	Monopolar palpation probe ø 5mm 350mm

Monopolar cables - 3.5 m



Accessories for knife CEV135-5
Knife blades



^(D) Distributed by Integra MicroFrance SAS (France) - For corresponding manufacturer part numbers, see table in annex

Palpation probe

	1/3			
	1/1		CEV204 320 mm - Ø 5mm	Round probe
	1/1		CEV204G45 450 mm - Ø 5mm	Round probe, graduated 10 to 150 mm
	1/1		CEV205 340 mm - Ø 5mm	Flat probe
	1/3		CEV207 410 mm - Ø 5mm	Double ended probe, round end flap graduated 10 to 150 mm

Articulated retractor

			Flexible retractor CEV416 380mm - Ø 5mm	1/3
	CEV413 370mm - Ø 5mm		Retractor with 3 blades 35mm	1/3
	Nouvelle CEV425 320mm - Ø 5mm		Retractor diamond design	1/3
	CEV423 400mm - Ø10mm		Retractor with 3 blades 65mm	1/3
	CEV453 400mm - Ø10mm		Retractor with 5 blades 65mm	1/3
	CEV453A 330mm - Ø10mm		Articulated retractor with 5 blades 65mm	1/3

NON Modular

Complete instruments

Flexible tension arm delivered with instruments holder CEV980-3

Accessories for flexible tension arm

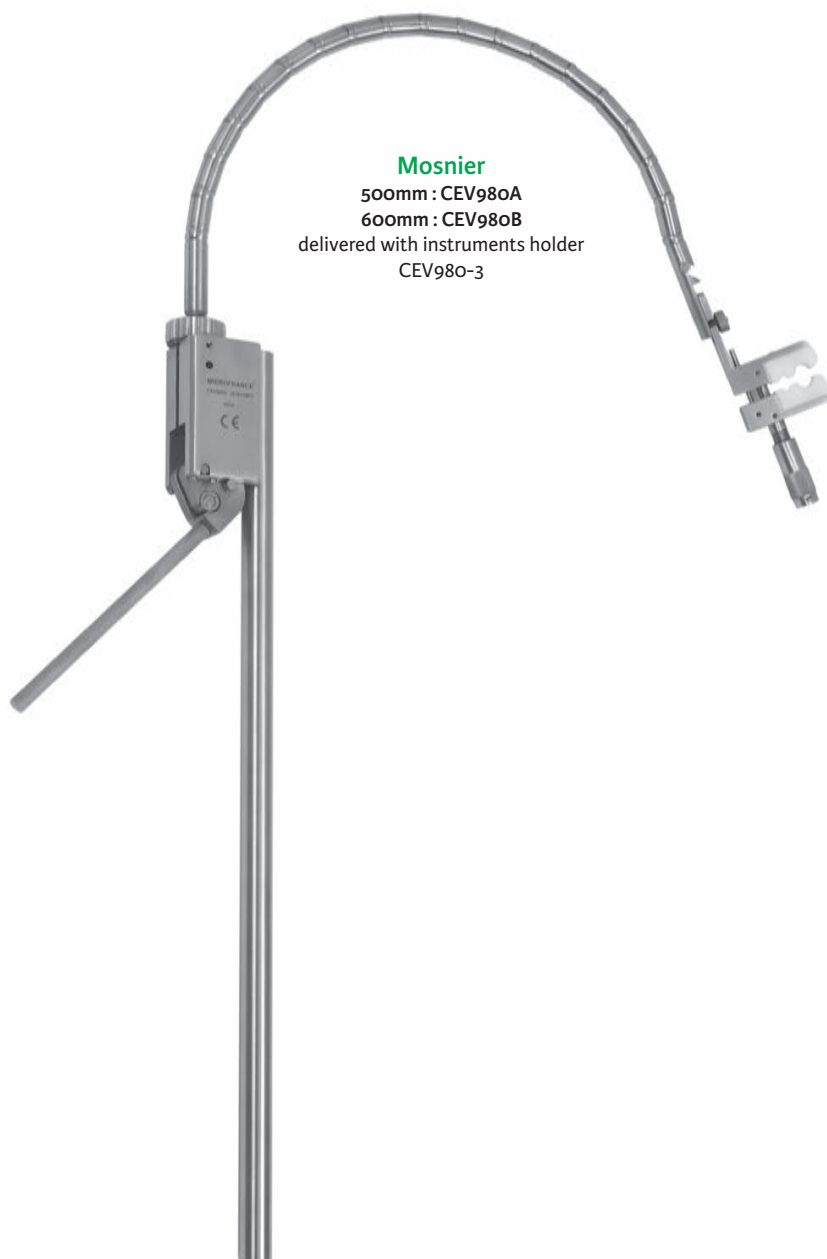

Mosnier
500mm : CEV980A
600mm : CEV980B
delivered with instruments holder
CEV980-3

CEV980-3
Instruments holder
Ø 5 et 10mm
Mosnier



CEV984
Operating table
clamp
with screw



CEV985
Operating table
clamp



Electric irrigation suction pump and accessories

Electric irrigation suction pump

Suction irrigation tubes
Sterile - Pack 10

Electric handle

CM201

CM217S^(D)

CM201-9



Eyes suction irrigation tubes for handle CM201-9

1/1

«L» Working length

1/3

Eyes hydro cannula Ø 10mm



CM20132H10
L 320mm

CM20128H-10
L 280mm

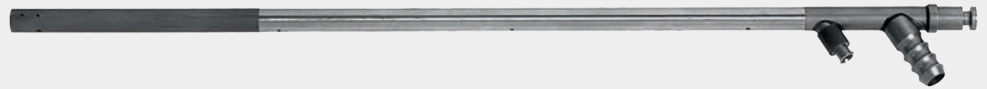

Eyes hydro cannula Ø 5mm



CM20132H-5
L 320mm

CM20128H-5
L 280mm

CM20140H5
L 400mm



Eyes cannula Ø 5mm



CM20132L-5
L 320mm



Cleaning sleeve for telescope



Cleaning sleeve for telescope odeg
Ø 10mm 300mm
Scale 1/3

CEV81

^(D) Distributed by Integra MicroFrance SAS (France) - For corresponding manufacturer part numbers, see table in annex



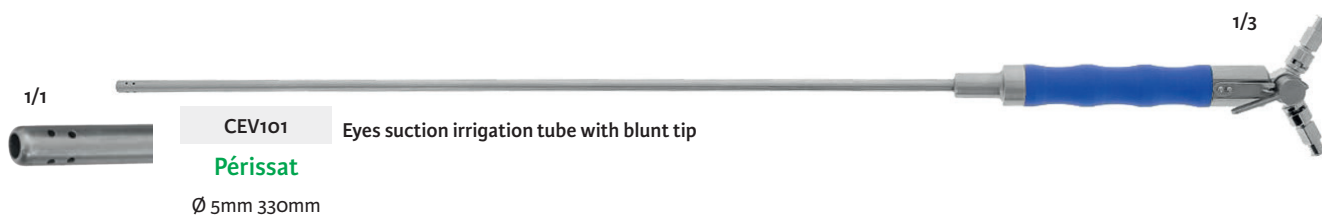

Suction irrigation tube



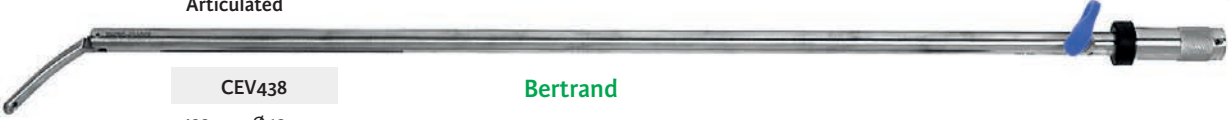

Modular suction irrigation tube

Eyes suction irrigation tube Ø 5mm		Handles for tube Ø 5mm
<p>1/1</p> <p>195mm CEV8103D5</p> <p>295mm CEV103-5</p> <p>395mm CEV9103D5</p>	<p>1/3</p>	<p>1/3</p> <p>CEV103AH</p>
<p>1/1</p> <p>195mm CEV8103G5</p> <p>295mm CEV103G5</p> <p>395mm CEV9103G5</p>	<p>Blunt tip</p> <p>1/3</p>	<p>1/3</p> <p>CEV103BG</p>
<p>Eyes suction irrigation tube Ø 10mm</p>		<p>Handles for tube Ø 10mm</p>
<p>1/1</p> <p>CEV103-10</p> <p>295mm</p>	<p>1/3</p>	<p>1/3</p> <p>CEV103AH</p>
<p>1/1</p> <p>CEV103P</p> <p>Prete</p> <p>410mm</p>		







Wire-pass

	Articulated	1/3
	CEV438 420mm - Ø 10mm Bertrand	
	Articulated	1/3
	CEV438B 335mm - Ø 5mm	
1/1	Retractable	1/3
CEV438D5 430mm - Ø 5mm Morino		
1/1	Retractable	1/3
CEV456 170mm - Ø 2.5mm		

Mintz set for punction

Sleeve - Ø 2.5mm - 240mm	1/3
CM170-1	
Sharp trocar	
CM170-2	
Smooth trocar	
CM170-3	

Needles

Insufflation needle with luer-lock	1/3
120mm	
CEV60-120	
150mm	
CEV60-150	
Punction needle with luer-lock	1/3
Ø 5mm - 300mm	
CEV65	
Ø 1.2mm - 40mm	
CEV24F	
Ø 2.0mm - 40mm	
CEV24G	<p>with a lateral perforation to purge</p>
	2/1

Cholangiography

1/3

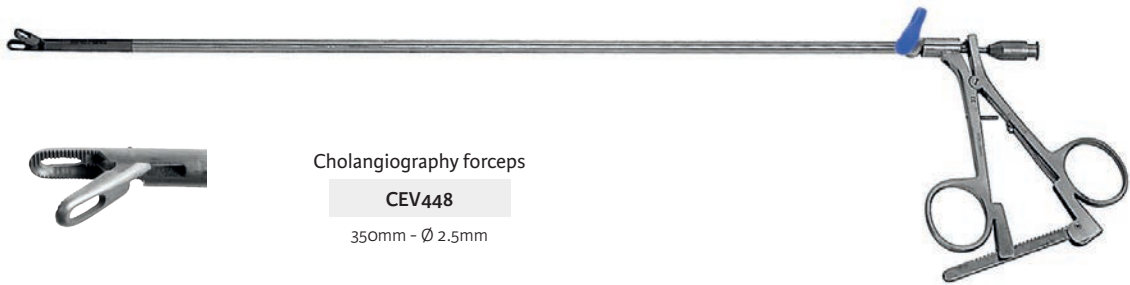

1/1



Cholangiography forceps

CEV448

350mm - Ø 2.5mm

1/3



Cholangiography needle

CEV440

230mm - int Ø 2.5mm

Sealing cap

CEV440P6

Pack 6



1/3

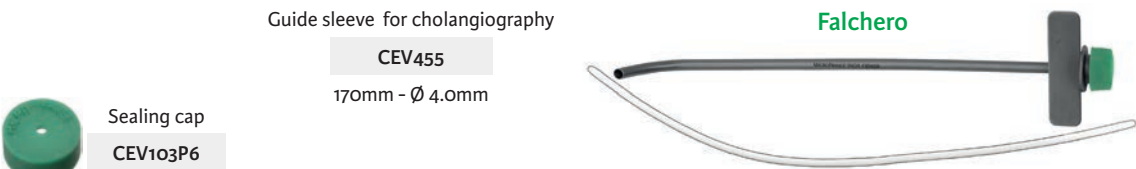

Guide sleeve for cholangiography

CEV455

170mm - Ø 4.0mm

Falchero



Sealing cap

CEV103P6

Pack 6

Cholédoscopy

1/3



Mauras

Guide sleeve for choledoscopy

CEV449

190mm - Ø 8mm

delivered with one guide CEV449G

1/3

Spare parts

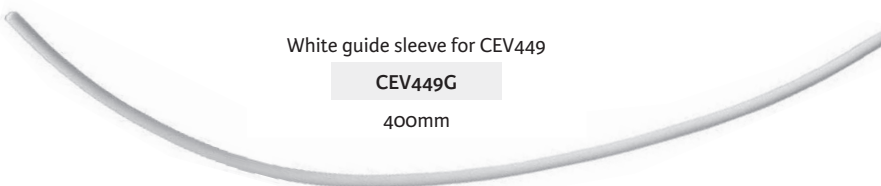

White guide sleeve for CEV449

CEV449G

400mm

Sealing cap

CEV105P6







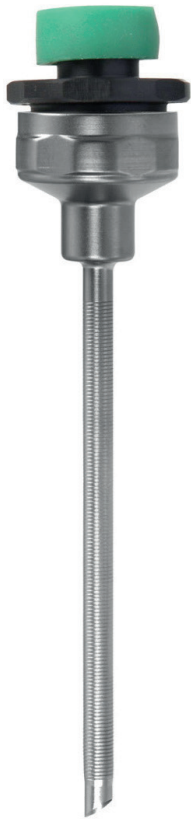

Pack 6









Trocar with metal cannula



Scale 1/1

			Working length	
			50 mm	80 mm
Trocar tip	smooth		CEV8143A4	CEV143A4
	pyramidal		CEV8143A3	CEV143A3
Sealing cap	green		CEV103P6 Pack 6	
Trocar head	magnetic		CEV177A3 Delivered complete with 1 magnetic valve and 1 green sealing cap	
	silicone		CEV127T3 Delivered complete with 1 silicone valve and 1 green sealing cap	
Valve for trocar head	magnetic		CEV179A5 Pack 6	
	silicone		CEV125P6 Pack 6	
Metal cannula, crenelated	with stopcock		CEV8143A7	CEV143A7
	without stopcock		CEV8143B7	CEV143B7







Composite trocar with silicone valve

			Working length	
			45 mm	70 mm
Trocar tip 	smooth 		CEV8826M	CEV326M
	pyramidal 		CEV8826P	CEV326P
Sealing cap	green 		CEV103P6 Pack 6	
Valve for trocar head	silicone 		CEV125P6 Pack 6	
Trocar body composed of 1 trocar head with composite cannula and silicone valve	smooth cannula without stopcock 		CEV8826L	CEV326L
	threaded cannula without stopcock 		CEV8826V	CEV326V









Scale 1/1

			Working length			
			50 mm	80 mm	100 mm	120 mm
Trocar tip 	blunt 		CEV8145A5	CEV145A5	CEV7145A5	CEV9145A5
	sharp 		CEV8145A3	CEV145A3	CEV7145A3	CEV9145A3
Sealing cap	blue		CEV105P6 Pack 6			
Head of trocar	magnetic valve		CEV177A5 delivered with one magnetic valve and one blue sealing cap			
	silicone valve		CEV127T delivered with one silicone valve and one blue sealing cap			
Valve for head of trocar	magnetic		CEV179A5 Pack 6			
	silicone		CEV125P6 Pack 6			
Sleeve	with stopcock	screw 	CEV8145A6	CEV145A6	CEV7145A6	CEV9145A6
		smooth 	CEV8145A7	CEV145A7	CEV7145A7	CEV9145A7
	without stopcock	screw 	CEV8145B6	CEV145B6	CEV7145B6	CEV9145B6
		smooth 	CEV8145B7	CEV145B7	CEV7145B7	CEV9145B7



CEV8126V

Body of trocar 5 mm diameter with silicone valve with screw sleeve, without stopcock		CEV8126V Working length 45 mm Montupet	CEV126V Working length 75 mm
Trocar tip for body of trocar 5mm diameter 	blunt 	CEV8126PM Working length 95 mm Montupet	CEV126PM Working length 120 mm
	sharp 	CEV8126P Working length 95 mm	CEV126P Working length 120 mm



Scale 1/1

				Working length	
				90 mm	130 mm
Trocar tip		blunt		CEV150-4	CEV9150A4
		sharp		CEV150-3	CEV9150A3
Sealing cap		red		CEV110P6 Pack 6	
Head of trocar		magnetic valve		CEV177A10 delivered with one magnetic valve and one red sealing cap	
		silicone valve		CEV127T10 Delivered with one silicone valve and one red sealing cap	
Valve for head of trocar		magnetic		CEV179A10 Pack 6	
		silicone		CEV125Q6 Pack 6	
Sleeve	with stopcock	screw		CEV150A6	CEV9150A6
		smooth		CEV150A7	CEV9150A7
	without stopcock	screw		CEV150B6	CEV9150B6
		smooth		CEV150B7	CEV9150B7

Dulucq smooth trocar tip palpator probe

Scale 2/3







Dulucq









CEV480
Ø 10 mm
Working length 180mm



Scale 1/1

			Working length	
			90 mm	130 mm
Trocar tip	blunt		CEV172A4	CEV9172A4
	sharp		CEV172A3	CEV9172A3
Sealing cap	Orange		CEV112P6 Pack 6	
Head of trocar	magnetic valve		CEV177A12 delivered with one magnetic valve and one orange sealing cap	
	silicone valve		CEV127T12 delivered with one silicone valve and one orange sealing cap	
Valve for head of trocar	magnetic		CEV179A12 Pack 6	
	silicone		CEV125Q6 Pack 6	
Sleeve	with stopcock	screw	CEV172A6	CEV9172A6
		smooth	CEV172A7	CEV9172A7
	without stopcock	screw	CEV172B6	CEV9172B6
		smooth	CEV172B7	CEV9172B7

	Ø 5.5 mm			Ø 10.5 mm		Ø 12.5 mm	
1/3	CEV805I	CEV105	CEV105I	CEV110I	CEV112I	CEV122I	CEV212
							
	Working length 50mm with stopcock	Working length 80mm without stopcock	Working length 80mm with stopcock	Working length 80mm with stopcock	Working length 120mm with stopcock	Working length 80mm with stopcock	Working length 120mm without stopcock
	Montupet						

Spring for trumpet valve trocar



CEV105R
Ø 5.5mm

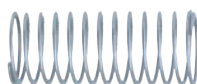

CEV110R
Ø 10.5mm

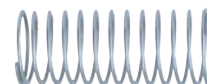

CEV112R
Ø 12mm

Sealing cap for trumpet valve trocars
see page 69



			Diameter		
			Ø 5.5mm	Ø 10mm	Ø 12.5mm
Trocar tip		blunt	CEV145-4	CEV150-4	-
		sharp	CEV145-3	CEV150-3	CEV172-3
Sealing cap					
			CEV105P6 Pack 6	CEV110P6 Pack 6	CEV112P6 Pack 6
Head of trocar	with stopcock				
			CEV178-5	CEV278-10	CEV278-12
		without stopcock		-	
			CEV177-5		CEV177-12
Sleeve	without stopcock	screw			
			CEV145-6	CEV150-6	CEV172-1
		smooth			-
			CEV145-7	CEV150-7	



CEV103P6

Ø 3.5mm

Pack 6



CEV105P6

Ø 5.5mm

Pack 6



CEV110P6

Ø 10.5mm

Pack 6



CEV112P6

Ø 12mm

Pack 6

Sealing cap for trocar

1/1



CEV155A

from Ø 10.5 to 5.5mm



CEV156A

from Ø 12/13 to 5.5mm



CEV181A

from Ø 12/13 to 10.5mm



CEV155B

Pack 6

Silicone ring for
attaching 15mm
reducer sleeve

1/3



CEV153

135 mm

from Ø 5.5 to
3.5mm

CEV155

135 mm

from Ø 10.5 to
5.5mm

CEV155-1

65 mm

from Ø 10.5 to
5.5mm

CEV155P

135 mm

from Ø 12/13 to
5.5mm

Tube
interne
Ø 5mm



CEV156

135 mm

from Ø 12/13 to
10.5mm

CEV181

135 mm

from Ø 12/13 to
10.5mm

CEV181-1

65 mm

from Ø 12/13 to
10.5mm

Reducer sleeve for trocar

Double retractor

1/3



Descottes

CEV417

200 mm

pair

Double retractor, blunt



CEV418

200 mm

pair

Double retractor, blunt



Mosnier









CEV419

160 mm







pair

Double retractor, blunt



Trocars 85mm

Scale 1/3	Blunt trocar tip	Sharp trocar tip	Flexible threaded cannula
Ø 5.5mm	CET105-1 	CET105-2 	CET105-3 
Ø 10.5mm	CET110-1 	CET110-2 	CET110-3 
Ø 12.5mm	CET112-1 	CET112T2 	CET112-3 
Joints : voir page 69			

Forceps, non modular instruments

Jaws Scale 1/1	Handle	Reference
 Manhès curette forceps 12x5mm Working length 355mm	 Angled	CM107U
 curette forceps 12x5mm, Double-action jaws Working length 355mm	 Angled	CEV444
 fenestrated forceps 20x5mm, curved tube Working length 340mm	 Axial, with ratchet  Curved tube	CET525

Modular forceps

 Manhès curette insert 12x5mm Ø 5mm	 Rotatable : page 40 - 45  Non rotatable : page 46 - 47	Working length		
		Short	standard	Large
		CEV8107IU 245mm	CEV107IU 345mm	CEV9107IU 445mm













1/2













Belghiti	Soubrane	Belghiti	Dousset	Gayet	Partenski
215mm	215mm	215mm	290mm	220mm	190mm
CEV392D20	CEV392S20	CEV392P20	CEV392D30	CEV392G24	CEV392R15
straight	straight	straight	straight	straight	bayonet
Jaws 2mm	Jaws 2mm double irrigation	Serrated jaws 2mm	Jaws 3mm double irrigation	Jaws 5x15mm	Jaws 4x10mm









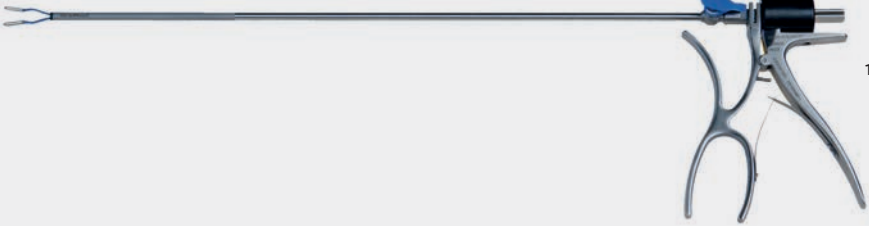

Semi-modular

		Insert with tubes	Handle
		Insert insulated tube Scale 1/1	Working length
			Page #
	 <p>Babcock Insert</p>	CEV391IU 335 mm	 <p>Rotatable 40 -> 45</p>
	 <p>Curved scissors insert, serrated blades 8 mm</p>	CEV393IU 330 mm	
	 <p>Straight scissors insert, serrated blades 8mm</p>	CEV394IU 330 mm	
	 <p>Fenestrated insert, 3x12mm jaws</p>	CEV395IU 335 mm	
	 <p>Alligator jaws insert 6 mm</p>	CEV396IU 330 mm	
	 <p>Dissector insert, medium curved 10 mm jaws</p>	CEV398IU 340 mm	
	 <p>Allis Grasping insert</p>	CEV399IU 335 mm	
	-	-	
 <p>CEV39L Adapter cleaning luer-lock for tube insert</p>			

NON Modular
Complete instruments

Jaws Scale 1/1	Handle	Working length
 Babcock forceps	 Angled with long ratchet	CEV391BU 355 mm
–	–	–
 Straight scissors, serrated blades, 8mm	 Angled	CEV394BU 350 mm
 Fenestrated forceps, 3x12mm jaws	 Angled with long ratchet	CEV395BU 355 mm
–	–	–
–	–	–
 Allis Grasping forceps with teeth	 Angled with long ratchet	CEV399BU 355 mm
 Needle-holder, tungsten straight jaws	 Axial	CEV992B 340 mm
 Needle-holder, tungsten left curved jaws		CEV992C 340 mm

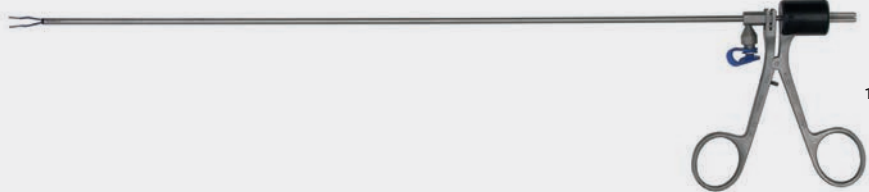
NON Modular			
Complete instruments : Bipolar forceps			
Jaws Scale 1/1	Handle		Working length
 Gayet Forceps, fenestrated jaws, 10x3mm, graduated tube 100mm		Ergonomic bipolar	CEV397BG 305mm
			
 Forceps, 2mm spatula jaws		Ergonomic bipolar	CEV397C 305mm
			
 Forceps, 2mm serrated jaws		Angled bipolar	CEV397 305mm
			



Cadière forceps

Forceps without port
Fenestrated forceps
percutaneous

CEV350
195mm
Cadière

1/1

1/3



Palpation probe

Round probe Ø 3.5mm 330mm
CEV203

1/1

1/3



Monopolar hooks

1/1 **CEV390B** Ø3.5mm, Working length 330mm, round tip 1/3

1/1 **CEV390C** Ø3.5mm Working length 355mm, 90° 1/3

Page 55

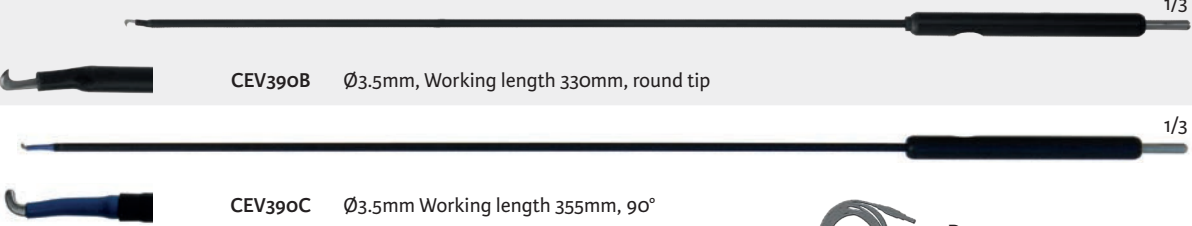

Suction irrigation tube

Eyes suction irrigation tube, graduated 50/100/150mm

1/1 **CEV103G3** 295mm 1/3

Ø 3.5mm

Graduated suction irrigation tube for handle CEV103GH or CEV103BG

1/3

Handle for suction tube CEV103G3

CEV103GH **CEV103BG**



Iannelli knot pusher

1/1 **CEV342** 440mm working length 340mm Ø 3.5mm 1/3



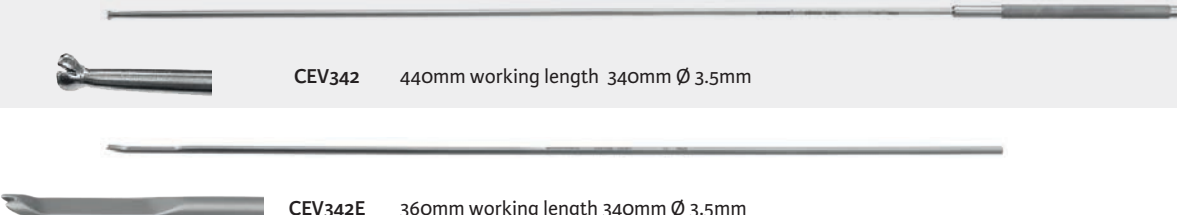

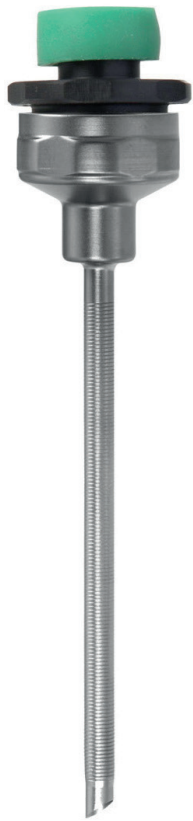

1/1 **CEV342E** 360mm working length 340mm Ø 3.5mm 1/3



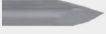





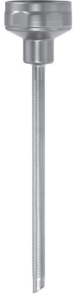

Trocart métal



Scale 1/1

			Working length	
			50 mm	80 mm
Trocar tip	blunt		CEV8143A4	CEV143A4
	sharp		CEV8143A3	CEV143A3
Sealing cap	Green		CEV103P6 Pack 6	
Head of trocar	magnetic valve		CEV177A3 delivered with one magnetic valve and one green sealing cap	
	silicone valve		CEV127T3 delivered with one silicone valve and one green sealing cap	
Valve for head of trocar	magnetic		CEV179A5 Pack 6	
	silicone		CEV125P6 Pack 6	
Metal sleeve	with stopcock		CEV8143A7	CEV143A7
	without stopcock		CEV8143B7	CEV143B7



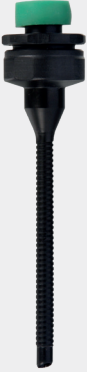



Trocart with composite sleeve and silicone valve

		Working length	
		45 mm	70 mm
Trocar tip 	blunt 	CEV8826M	CEV326M
	sharp 	CEV8826P	CEV326P
Sealing cap	green 	CEV103P6 Pack 6	
Valve for head of trocar	silicone 	CEV125P6 Pack 6	
Body of trocar with head of trocar with silicone valve and composite sleeve	with smooth sleeve without stopcock 	CEV8826L	 CEV326L
	with screw sleeve without stopcock 	CEV8826V	 CEV326V









Scale 1/1







Monopolar hooks

			1/3
	<p>1/1</p> <p>CEV890</p> <p>225mm Ø 3.5mm</p>	<p>Montupet</p>	
			1/3
	<p>1/1</p> <p>CEV890C</p> <p>90deg 225mm Ø 3.5mm</p>		<p>Page 55</p>

Retractable knife









			1/3
	<p>1/1</p> <p>CEV898</p> <p>90mm Ø 3.5mm</p> <p>delivered with one blade CEV898L</p>		
			1/3
	<p>1/1</p> <p>CEV898L</p> <p>Knife blade for CEV898</p> <p>Pack 3</p>		

Suction irrigation tube

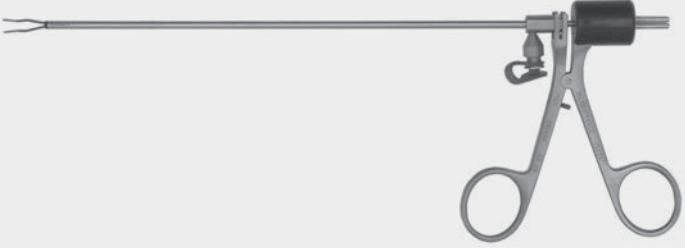





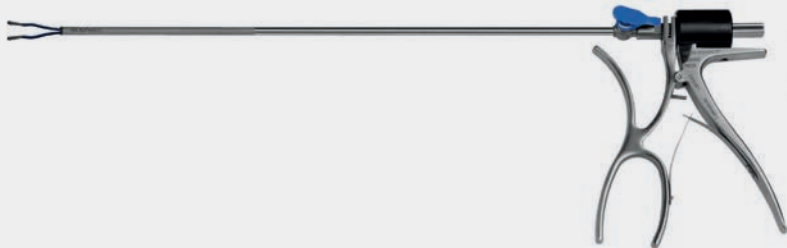



		<p>Eyes suction irrigation tube, graduated 50/100/150mm</p> <p>CEV8103G3</p> <p>Ø 3.5mm 195mm</p> <p>Eyes suction irrigation tube, blunt graduated 50/100/150mm for handle CEV103GH or CEV103BG</p>		1/3
			<p>CEV103GH</p> <p>Handle</p>	
			<p>CEV103BG</p> <p>Handle</p>	1/3
	<p>1/1</p> <p>CEV896</p> <p>Ø 3.5mm 220mm</p>		<p>Eyes suction irrigation tube with blunt tip</p>	1/3

NON Modular

Complete instruments : bipolar forceps

Jaws Scale 1/1	Handle	Working length
 <p>Bipolar forceps 1.5mm serrated jaws</p>	 <p>Angled Bipolar</p>	<p>CEV897 250 mm</p>
 <p>1/3</p>		
 <p>Bipolar forceps, fenestrated jaws 10x3mm jaws</p>	 <p>Ergonomic bipolar</p>	<p>CEV897BG 250 mm</p>
 <p>1/3</p>		
 <p>Bipolar forceps 2mm serrated jaws</p>	 <p>Ergonomic bipolar</p>	<p>CEV897C 250 mm</p>
 <p>1/3</p>		











Semi-Modular		
Insert with tube		Handle
Insert insulated tube Scale 1/1	Working length	Page #
	 Babcock insert CEV891IU 235 mm	 Rotatable 40 -> 45
 Curved scissors insert, serrated blades 8 mm CEV893IU 230 mm		
 Straight scissors insert, serrated blades 8mm CEV894IU 230 mm		
 Fenestrated insert, 3x12mm jaws CEV895IU 235 mm		
 Allis Grasping forceps CEV899IU 220 mm		
 Alligator jaws insert, 6 mm CEV896IU 235 mm		
 Dissector insert, Medium curved 10 mm jaws CEV898IU 230 mm		
	CEV39L Adapter cleaning luer-lock for tube insert	

NON Modular

Complete instruments











Jaws Scale 1/1	Handle	Working length
 Montupet Babcock forceps	 Angled with long ratchet	CEV891MU 200 mm
—	—	—
 Montupet Straight scissors, serrated blades 8mm	 Angled	CEV894MU 220 mm
 Montupet Fenestrated forceps, 3x12mm jaws	 Angled with long ratchet	CEV895MU 195 mm
 Allis Grasping forceps with teeth	 Angled with long ratchet	CEV899U 220 mm









NON Modular

Complete instruments

De Lagausie instruments

Jaws Scale 1/1	Handle	Working length
 De Lagausie Fenestrated forceps, 3x12mm jaws	 Axial	CEV995MU 220 mm
 De Lagausie Straight scissors, serrated blades 8mm	 Axial	CEV996MU 220 mm
 De Lagausie Alligator forceps, 6mm serrated jaws	 Axial	CEV997MU 210 mm
 De Lagausie Dissector, medium curved 10mm jaws	 Axial	CEV998MU 220 mm

Needle-holder

 Montupet Needle-holder, tungsten straight jaws	 Angled with long ratchet	CEV892 220 mm
 Reinberg Needle-holder, straight jaws	 Axial	CEV992 220 mm
 Needle-holder, left curved tungsten jaws	 Axial	CEV992D 220 mm

Scale 1/3

Curved scissors, titanium large curved blades, 15 mm



Working length 230 mm

CEC8605GT

Adson-Brown forceps with teeth



Working length 230 mm

CEC8522

Needle-holder, tungsten straight jaws, 1 x 10 mm



Working length 230 mm

CEC8500T5

Needle-holder, titanium automatic jaws



Working length 230 mm

CEC8650T

Scale 1/2
Working length «L»



Trocar holder ring
for trocar Ø 10mm

MCLP70

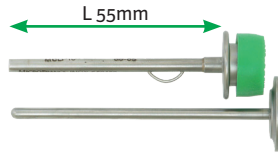

Trocar without valve 55mm
with blunt trocar tip

MCLP10

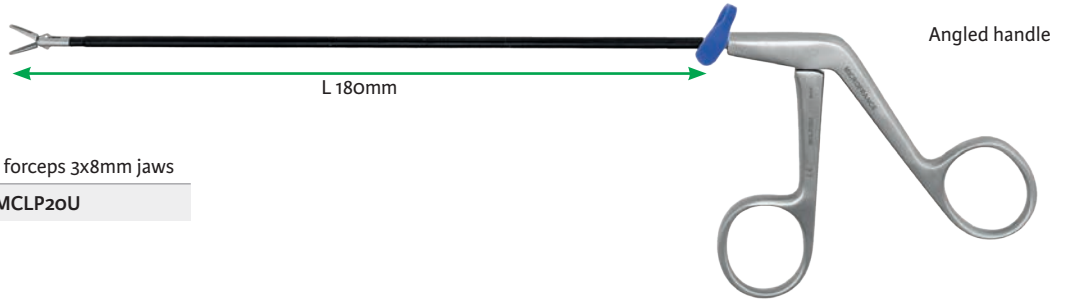

Angled handle

Fenestrated forceps 3x8mm jaws

MCLP20U



Fenestrated forceps 3x8mm jaws

MCLP25U



Forceps, alligator jaws, 6mm

MCLP30U



Curved scissors, blades 4mm

MCLP40U



Monopolar hook

MCLP50



Round palpation probe

MCLP60



L 180mm

MCLP50

L 100mm

MCLP30U

MCLP30U

Axial handle

MCLP40U

Axial handle



Page 55

Scale 1/2

Double blunt retractor
180mm

MCLT10

Small size 8x35 / 15x40mm

MCLT11

large size 8x35 / 15x50mm

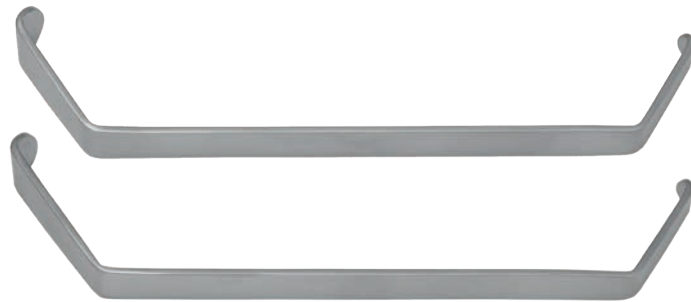

Blunt curved elevator
190mm

MCLT20

2mm

MCLT21

4mm



Peanut-holder



200mm - Ø 3mm

MCLT30

Axial handle



Suction tube elevator
200mm - Ø 3mm

MCLT40

malleable



Nerve eye suction tube
with finger control
200mm - Ø 3mm

MCLT50

malleable





Scheyre biopsy rectal forceps, 5mm

Hirschsprung's disease

1/3



Curette jaws insert and tube Ø 5mm, non sterile, **single use** (pack 3) for biopsy

Handle non sterile, resterilizable

1/4

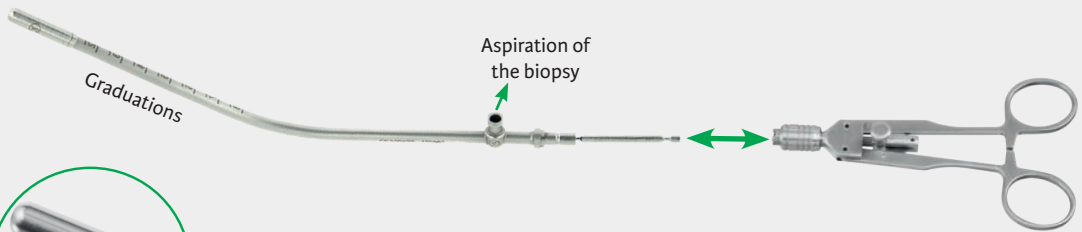

Biopsy diameter
3 or 5mm

CEV504S3 Insert Ø 3mm

CEV504S5 Insert Ø 5mm

CEV504PS Axial handle



Single use
to sterilize

Precaution:

If the single use symbol is on the device label then this device is designed for single patient use only. Do not reuse, reprocess, or resterilize this product. Reuse, reprocessing, or resterilization may compromise the structural integrity of the device and/or create a risk of contamination of the device, which could result in patient injury, illness, or death.

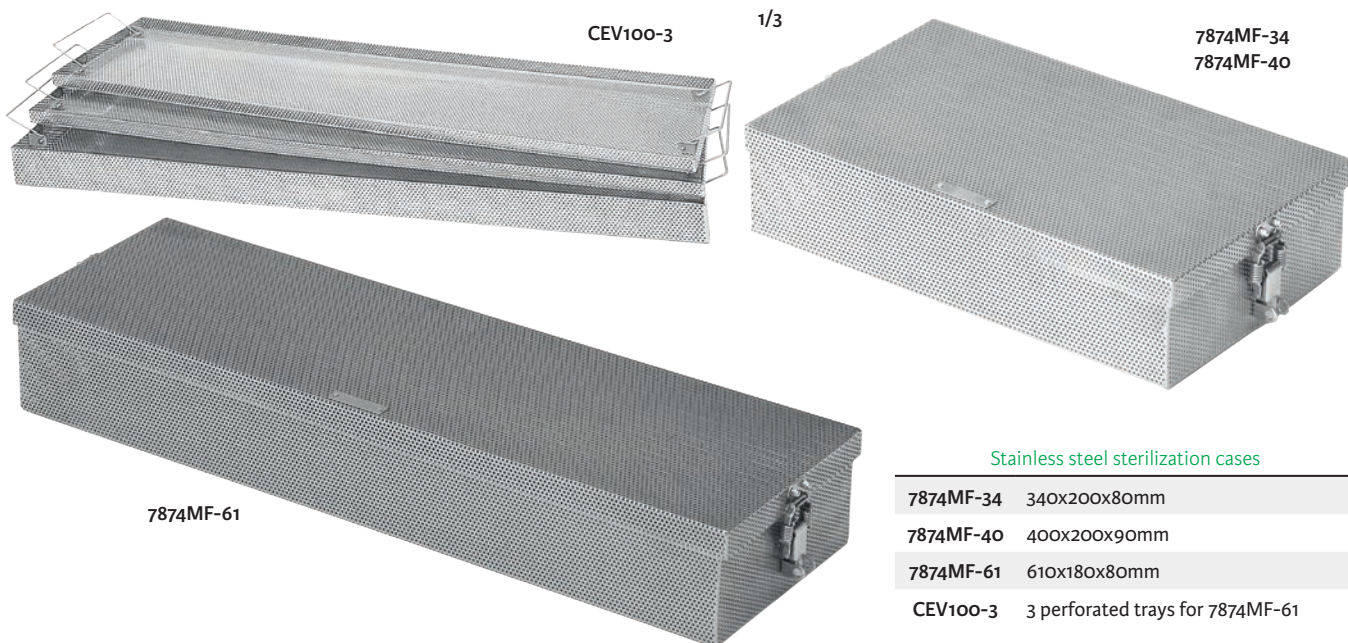

Stainless steel sterilization cases

7874MF-34	340x200x80mm
7874MF-40	400x200x90mm
7874MF-61	610x180x80mm
CEV100-3	3 perforated trays for 7874MF-61



371001
Case 530x255x150mm with 3 levels



MCO731^(D)
Surgical instrument oil



CEV56
Stainless steel cap
for luer-lock cleaning port
Pack 1



CEV57
Silicone cap
for luer-lock cleaning port
Pack 6

^(D) Distributed by Integra MicroFrance SAS (France) - For corresponding manufacturer part numbers, see table in annex



Numerical index

3

3717001 87

7

7874MF-34 87
 7874MF-40 87
 7874MF-61 87

CEC

CEC8500T5 83
 CEC8522 83
 CEC8605GT 83
 CEC8650T 83

CET

CET105-1 70
 CET105-2 70
 CET105-3 70
 CET110-1 70
 CET110-2 70
 CET110-3 70
 CET112-1 70
 CET112-3 70
 CET112T2 70
 CET525 70

CEV

CEV24F 60
 CEV24G 60
 CEV39L 26, 72, 80
 CEV56 87
 CEV57 87
 CEV60-120 60
 CEV60-150 60
 CEV65 60
 CEV81 58
 CEV100-3 87
 CEV101 59
 CEV103-5 59
 CEV103-10 59
 CEV103AH 59
 CEV103BG 59, 75, 78
 CEV103G3 75
 CEV103G5 59
 CEV103GH 59, 75, 78
 CEV103P 59
 CEV103P6 61, 62, 63, 69, 76, 77
 CEV104IU 26
 CEV105 67
 CEV105I 67
 CEV105P6 64, 68, 69
 CEV105R 67
 CEV107IU 70
 CEV110I 67
 CEV110P6 65, 68, 69

CEV110R 67
 CEV112I 67
 CEV112P6 66, 68, 69
 CEV112R 67
 CEV114MU 28
 CEV122I 67
 CEV125P6 62, 63, 64, 76, 77
 CEV125Q6 65, 66
 CEV126P 64
 CEV126PM 64
 CEV126V 64
 CEV127T 64
 CEV127T3 62, 76
 CEV127T10 65
 CEV127T12 66
 CEV130 53
 CEV132 51
 CEV133 53
 CEV133-1 53
 CEV134 51
 CEV134BG 51
 CEV135-5 55
 CEV136 51
 CEV143A3 62, 76
 CEV143A4 62, 76
 CEV143A7 62, 76
 CEV143B7 62, 76
 CEV145-3 68
 CEV145-4 68
 CEV145-6 68
 CEV145-7 68
 CEV145A3 64
 CEV145A5 64
 CEV145A6 64
 CEV145A7 64
 CEV145B6 64
 CEV145B7 64
 CEV150-3 65, 68
 CEV150-4 65, 68
 CEV150-6 68
 CEV150-7 68
 CEV150A6 65
 CEV150A7 65
 CEV150B6 65
 CEV150B7 65
 CEV153 69
 CEV155 69
 CEV155-1 69
 CEV155A 69
 CEV155B 69
 CEV155P 69
 CEV156 69
 CEV156A 69
 CEV172-1 68
 CEV172-3 68
 CEV172A3 66
 CEV172A4 66
 CEV172A6 66
 CEV172A7 66
 CEV172B6 66
 CEV172B7 66
 CEV177-5 68

CEV177-12 68
 CEV177A3 62, 76
 CEV177A5 64
 CEV177A10 65
 CEV177A12 66
 CEV178-5 68
 CEV179A5 62, 64, 76
 CEV179A10 65
 CEV179A12 66
 CEV181 69
 CEV181-1 69
 CEV181A 69
 CEV203 75
 CEV204 56
 CEV204G45 56
 CEV205 56
 CEV207 56
 CEV211U 15
 CEV212 67
 CEV220U 13
 CEV225 54
 CEV225A 54
 CEV229-1A 54
 CEV229-2A 54
 CEV229-3A 54
 CEV229-4A 54
 CEV229B 54
 CEV230-1 54
 CEV278-10 68
 CEV278-12 68
 CEV310 39
 CEV321 15
 CEV326L 63, 77
 CEV326M 63, 77
 CEV326P 63, 77
 CEV326V 63, 77
 CEV342 75
 CEV342E 75
 CEV350 75
 CEV390B 75
 CEV390C 75
 CEV391BU 73
 CEV391IU 72
 CEV392D20 71
 CEV392D30 71
 CEV392G24 71
 CEV392P20 71
 CEV392R15 71
 CEV392S20 71
 CEV393IU 72
 CEV394BU 73
 CEV394IU 72
 CEV395BU 73
 CEV395IU 72
 CEV396IU 72
 CEV397 74
 CEV397BG 74
 CEV397C 74
 CEV398IU 72
 CEV399BU 73
 CEV399IU 72
 CEV404 29

CEV405BG	3	CEV511	15	CEV615T1U.....	12
CEV405U	3	CEV512.....	15	CEV616IU	16
CEV406IU	4	CEV514MU	28	CEV617IU	12
CEV406U	5	CEV515.....	13	CEV620T1U.....	12
CEV407IU.....	4	CEV521.....	11	CEV621T1U.....	10
CEV407U.....	5	CEV525	3	CEV622IU.....	39
CEV410	9	CEV525C.....	3	CEV623T1U	26
CEV413.....	56	CEV526	30	CEV624IU.....	12
CEV416	56	CEV527	30	CEV625CU	2
CEV417.....	69	CEV530.....	9	CEV625DU	2
CEV418	69	CEV531-2.....	19	CEV625EU.....	6
CEV419	69	CEV531T3U	19	CEV625H	48
CEV420.....	11	CEV532.....	19	CEV625P1U	2
CEV421	11	CEV532IU	18	CEV625PU.....	6
CEV423	56	CEV533-2.....	9	CEV625T1U.....	2
CEV425	56	CEV535	33	CEV626-1.....	30
CEV430.....	21	CEV538-10.....	24	CEV627I.....	30
CEV431-65.....	35	CEV538T5.....	23	CEV628-5N	46
CEV432	9	CEV538TU.....	22	CEV628-10	44
CEV433	9	CEV540-5.....	23	CEV628P5.....	41
CEV433-1.....	8	CEV540-10	24	CEV630-1A	52
CEV433DU	6	CEV544.....	23	CEV630C	52
CEV433H	8	CEV544IU	22	CEV632-1A	50
CEV435-1.....	33	CEV560.....	38	CEV633-1A.....	52
CEV435-2	33	CEV560-1	38	CEV633H	48
CEV438	60	CEV565	38	CEV634-1A	50
CEV438B.....	60	CEV566.....	38	CEV635-1.....	32
CEV438D5.....	60	CEV567	38	CEV636-1A	50
CEV440.....	61	CEV568.....	38	CEV637I.....	50
CEV440P6.....	61	CEV570.....	31	CEV638T5NU.....	46
CEV442.....	25	CEV580-2.....	51	CEV640-10.....	24
CEV442E.....	25	CEV580-3.....	53	CEV641DU.....	17
CEV442Z	25	CEV600H	48	CEV641FU	17
CEV443.....	55	CEV601-1.....	20	CEV641T1U	18
CEV444.....	70	CEV601P.....	20	CEV642H.....	48
CEV445-5.....	25	CEV602-1	10	CEV642HD.....	48
CEV445IU.....	25	CEV603I	39	CEV642T1U.....	18
CEV448.....	61	CEV604T1U	26	CEV642TFU	17
CEV449.....	61	CEV604T3U	26	CEV643IU.....	17
CEV449G.....	61	CEV605BGPU	27	CEV646B5U	43, 49
CEV453.....	56	CEV605GPU	27	CEV647B5U.....	43, 49
CEV453A.....	56	CEV605GTU	26	CEV648B5U	43, 49
CEV455.....	61	CEV605GU.....	26	CEV649-10B.....	45
CEV456.....	60	CEV605T1U.....	26	CEV649B5U	43, 49
CEV460U	5	CEV605T3U	26	CEV649BGPU	27
CEV470T1U.....	5	CEV605T5U	26	CEV649C5U.....	27, 43, 49
CEV470U	3	CEV606-1.....	14	CEV649G5.....	7
CEV480.....	65	CEV607CU	27	CEV649GPU.....	27
CEV500-A10	24	CEV607DU	27	CEV649M5.....	7
CEV500T5.....	23	CEV607T1U.....	27	CEV649P5.....	47
CEV500TU	22	CEV607U.....	27	CEV649T5BU	43, 49
CEV501	21	CEV608-1	34	CEV649T5NU.....	46
CEV501-2	21	CEV608D	34	CEV649X5.....	45
CEV502.....	11	CEV610-1.....	8	CEV650T5D	23
CEV503.....	29	CEV611H	48	CEV650TU	22
CEV504PS	86	CEV611T1U	14	CEV651-1	20
CEV504S3	86	CEV612DU.....	16	CEV652I.....	20
CEV504S5	86	CEV612LH	48	CEV653-1.....	29
CEV505.....	33	CEV612T1U.....	14	CEV658-10	44
CEV506	15	CEV613T1U.....	14	CEV660T1U	4
CEV507.....	9	CEV614T1U.....	12	CEV661IU	4
CEV508.....	35	CEV615H.....	48	CEV662IU.....	4

CEV669B	50, 52	CEV992D	82	CEV8624IU	12
CEV669BG	50, 52	CEV995MU	82	CEV8625CU	2
CEV669E	48	CEV996MU	82	CEV8625DU	2
CEV670DU	6	CEV997MU	82	CEV8625EU	6
CEV670T1U	2	CEV998MU	82	CEV8625H	48
CEV671T1U	4	CEV1019T5BU	40	CEV8625T1U	2
CEV700T5	23	CEV1019T5NUC	46	CEV8626I	30
CEV700T5D	23	CEV1039G5U	40	CEV8627I	30
CEV720	47	CEV1039T5NU	46	CEV8633H	48
CEV720B	47	CEV1039T5TBU	40	CEV8641T1U	18
CEV720BRUC	42	CEV1059-10B	44	CEV8642H	48
CEV720RU	42	CEV2295A	54	CEV8642HD	48
CEV721	11	CEV6285R	41	CEV8642T1U	18
CEV725	3	CEV6385RU	41	CEV8646B5U	43, 49
CEV728BR	44	CEV6795B	50, 52	CEV8647B5U	43, 49
CEV728BR5U	42	CEV7145A3	64	CEV8648B5U	43, 49
CEV728T5	41	CEV7145A5	64	CEV8649B5U	43, 49
CEV728T10	44	CEV7145A6	64	CEV8649BGPU	27
CEV738-5	23	CEV7145A7	64	CEV8649C5U	27, 43, 49
CEV738D5	23	CEV7145B6	64	CEV8649GPU	27
CEV738T5	23	CEV7145B7	64	CEV8649P5	47
CEV740-5	23	CEV7285RU	42	CEV8649T5NU	46
CEV744T5	23	CEV7625I	7	CEV8649T5TBU	43, 49
CEV760	5	CEV7660I	7	CEV8649X5	45
CEV804	28	CEV8103D5	59	CEV8650TU	22
CEV805I	67	CEV8103G3	78	CEV8660T1U	4
CEV815	3	CEV8103G5	59	CEV8670DU	6
CEV821G	11	CEV8104IU	26	CEV8826L	63, 77
CEV825	54	CEV8107IU	70	CEV8826M	63, 77
CEV830	53	CEV8126P	64	CEV8826P	63, 77
CEV834	51	CEV8126PM	64	CEV8826V	63, 77
CEV890	78	CEV8126V	64	CEV9103D5	59
CEV890C	78	CEV8143A3	62, 76	CEV9103G5	59
CEV891IU	80	CEV8143A4	62, 76	CEV9104IU	26
CEV891MU	81	CEV8143A7	62, 76	CEV9107IU	70
CEV892	82	CEV8143B7	62, 76	CEV9134BG	51
CEV893IU	80	CEV8145A3	64	CEV9145A3	64
CEV894IU	80	CEV8145A5	64	CEV9145A5	64
CEV894MU	81	CEV8145A6	64	CEV9145A6	64
CEV895IU	80	CEV8145A7	64	CEV9145A7	64
CEV895MU	81	CEV8145B6	64	CEV9145B6	64
CEV896	78	CEV8145B7	64	CEV9145B7	64
CEV896IU	80	CEV8407IU	4	CEV9150A3	65
CEV897	79	CEV8434I	8	CEV9150A4	65
CEV897BG	79	CEV8445IU	25	CEV9150A6	65
CEV897C	79	CEV8538TU	22	CEV9150A7	65
CEV898	78	CEV8544IU	22	CEV9150B6	65
CEV898IU	80	CEV8604T1U	26	CEV9150B7	65
CEV898L	78	CEV8605GTU	26	CEV9172A3	66
CEV899IU	80	CEV8605GU	26	CEV9172A4	66
CEV899U	81	CEV8605T1U	26	CEV9172A6	66
CEV904	28	CEV8607T1U	27	CEV9172A7	66
CEV915G	3	CEV8611H	48	CEV9172B6	66
CEV965	23	CEV8611T1U	14	CEV9172B7	66
CEV980-3	57	CEV8612DU	16	CEV9229-1	54
CEV980A	57	CEV8612LH	48	CEV9407IU	4
CEV980B	57	CEV8613T1U	14	CEV9445IU	25
CEV984	57	CEV8615H	48	CEV9500TU	22
CEV985	57	CEV8615T1U	12	CEV9544IU	22
CEV992	82	CEV8616IU	16	CEV9604-1	26
CEV992B	73	CEV8621T1U	10	CEV9605GTU	26
CEV992C	73	CEV8623T1U	26	CEV9605GU	26

CEV9605T1U26
 CEV9607T1U.....27
 CEV9611H.....48
 CEV9611T1U14
 CEV9612DU16
 CEV9612LH48
 CEV9614T1U12
 CEV9615H48
 CEV9615T1U12
 CEV9617IU12
 CEV9620T1U12
 CEV9623T1U26
 CEV9624IU12
 CEV9625CU2
 CEV9625DU2
 CEV9625H48
 CEV9625T1U2
 CEV9627I30
 CEV9630-1A52
 CEV9633H48
 CEV9634-1A50
 CEV9641T1U18
 CEV9642H48
 CEV9642HD48
 CEV9642T1U18
 CEV9646B5U43, 49
 CEV9647B5U43, 49
 CEV9648B5U43, 49
 CEV9649B5U43, 49
 CEV9649BGPU27
 CEV9649C5U27, 43, 49
 CEV9649GPU27
 CEV9649P547
 CEV9649T5NU46
 CEV9649T5TBU43, 49
 CEV9649X545
 CEV9650TU22
 CEV9660T1U4
 CEV9670DU6
 CEV9700T5D23
 CEV9738T523
 CEV9744T523
 CEV10195CU40
 CEV10195DU40
 CEV10195NAU46
 CEV10195RU40
 CEV10395DU40
 CEV10395RU40
 CEV72810R44
 CEV8229154
 CEV86341A50
 CEV86361A50
 CEV86795B50
 CEV96321A50
 CEV96331A52
 CEV96361A50
 CEV96795B50, 52
 CEV102910R44
 CEV864910B45

CEVA

CEVA10136
 CEVA10236
 CEVA10336
 CEVA10436
 CEVA11037
 CEVA11233
 CEVA52837
 CEVA52937

CM

CM10428
 CM10628
 CM107U70
 CM10955
 CM110U13
 CM111U15
 CM112U15
 CM113U15
 CM115U13
 CM120U13
 CM13153
 CM170-160
 CM170-260
 CM170-360
 CM20158
 CM201-958
 CM217S^(D)58
 CM20128H-558
 CM20128H-1058
 CM20132H-558
 CM20132H1058
 CM20132L-558
 CM20140H558

CP

CP391E55
 CP391M55
 CP391V55
 CP393-249, 71
 CP393-349, 71
 CP393-449, 71

MCEN

MCEN54P50, 52

MCLP

MCLP1084
 MCLP20U84
 MCLP25U84
 MCLP30U84
 MCLP40U84
 MCLP5084
 MCLP6084
 MCLP7084

MCLT

MCLT1085
 MCLT1185
 MCLT2085
 MCLT2185
 MCLT3085
 MCLT4085
 MCLT5085

MCO

MCO731^(D)87

S

SM63^(D)55
 SM64^(D)55
 SM65^(D)55

Integra MicroFrance® product reference number	Manufacturer part number equivalent
CM217S	CM217S
MCO731	430490
SM63	SM63
SM64	SM64
SM65	SM65

**Alphabetical index
Global**

A

Adson-Brown	83
Aesculap	49, 55, 71
Allal	17
Allis	15, 72, 73, 80, 81
Annibale	34

B

Begin	38
Belghiti	71
Berchtold	49, 55, 71
Bertrand	2, 3, 60
Bipolar	
<i>Bipolar cable</i>	49, 71
<i>Bipolar handle</i>	48, 50, 52
<i>Bipolar forceps fenestrated jaws</i>	51, 53, 74, 79
<i>Bipolar insert</i>	48
<i>Bipolar irrigation forceps</i>	71
<i>Non-insulated tube for bipolar insert</i>	50, 52
<i>Protection part for bipolar tip jaws</i>	48
Botella	52, 53
Bovie	55
Bowa	49, 55, 71

C

Cable	
<i>Bipolar cable</i>	49, 71
<i>Monopolar cable</i>	55
Cadière	75
Cannula	
<i>Eyes cannula</i>	58, 59
<i>Eyes cannula graduated</i>	59, 75, 78
<i>Eyes hydro cannula</i>	58
Cap	87
Cau	22
Clamp	
<i>Angled clamp</i>	36, 37
<i>Choledoque clamp</i>	38
<i>Curved clamp</i>	36, 37
<i>Debakey clamp</i>	30, 31, 33, 38
<i>Intestinal clamp</i>	35, 38
<i>Straight clamp</i>	30
Clamp applicator	38
Claw	14, 15
Clip applicator	39
Conmed	55
Crovella	4

D

De Lagausie	82
De Manzini	7
Delaitre	10, 11, 17, 18, 20, 21, 25, 32, 33, 35, 55
Descottes	69
Desmaizieres	4, 5, 30, 37
Desplantez	5
Dessi	50, 52
Dissector	19, 21, 82
Dousset	71
Drouard	25
Dulucq	31, 65
Duval	9

E

Electric suction irrigation pump	
<i>Cannula</i>	58
<i>Electric pump</i>	58
<i>Suction irrigation tubing</i>	58
Elevator	85
Elhadad	42
Emc	49, 71
Erbe	49, 55, 71

F

Falchero	61
Forceps	
<i>Alligator forceps</i>	13, 82
<i>Babcock forceps</i>	11, 73, 81
<i>Bipolar forceps fenestrated jaws</i>	51, 53, 74, 79
<i>Bipolar irrigation forceps</i>	71
<i>Cholangiography forceps</i>	61
<i>Curette forceps</i>	70
<i>Fenestrated forceps</i>	3, 5, 9, 70, 73, 75, 81, 82
<i>Forceps with teeth</i>	15, 73, 81, 83

G

Gayet	3, 50, 51, 52, 71, 74
Guide sleeve for Cholangiography - Choledoscopy	61

H

Handle	
Angled handle	40, 44, 46
Axial handle	41, 44, 46, 86
Bipolar handle	48, 50, 52
Electric handle	58
Ergonomic handle	42, 44, 47
Handle for suction tube	59, 75, 78
Henry	84
Hook	54, 75, 78, 84
Hüscher	8

I

Iannelli	75
Insert	
Alligator insert	12
Anvil circular suturing holder insert	39
Babcock insert	10
Bipolar insert	48, 50, 52
Clamp applicator insert	38
Cobra insert	14, 16
Curette insert	70
Curette insert for biopsy	86
Clamp insert	30, 32
Dissector insert	17, 18, 20
Dolphin insert	12
Enclume holder insert	39
Fenestrated insert	2, 4, 6, 7, 8, 16
Grasping insert	14
Intestinal clamp insert	34
Knot guide scissors insert	25
Monopolar hook jaws	54
Needle-holder insert	22
Protection part for bipolar tip jaws	48
Round jaws insert	6, 8
Serrated jaws insert	12
Scissors insert	26, 27, 29
Tiger insert	14
Wire insert for scissors jaws	27

Insert with insulated tube

Adapter luer-lock for tube insert cleaning port	26, 72, 80
Alligator insert	72, 80
Babcock insert	72, 80
Curved scissors insert	72, 80
Dissector insert	72, 80
Fenestrated insert	72, 80
Grasping insert	72, 80
Straight scissors insert	26, 72, 80

J

Johann	2, 3, 48
---------------	----------

K

Knife	
Knife blade	55, 78
Retractable knife	55, 78
Knot pusher	25, 75
Knot pusher guide scissors	25

L

Lamidey	49, 55, 71
----------------	------------

M

Manhès	12, 13, 14, 15, 28, 53, 55, 70
Martin	49, 55, 71
Massard	39
Mauras	61
Micro instrument	
Micro forceps	84
Micro nerve eye suction tube	85
Micro palpation probe	84
Micro scissors	84
Micro suction tube elevator	85
Mintz	60
Monopolar	
Monopolar cable	55
Monopolar hook	54, 75, 78, 84
Monopolar palpation probe	55
Retractable monopolar electrode	55
Montupet	3, 28, 53, 54, 63, 64, 67, 77, 78, 81, 82
Morino	39, 60
Mosnier	57, 69
Mouiel	23, 24, 50, 51

N

Needle	
<i>Cholangiography needle</i>	61
<i>Insufflation needle</i>	60
<i>Puncture needle</i>	60
<i>Sharp trocar for puncture needle</i>	60
<i>Smooth trocar for puncture needle</i>	60
Needle-holder	
<i>Automatic titanium jaws</i>	23, 83
<i>curved jaws</i>	24
<i>Straight jaws</i>	24
<i>Tungsten jaws</i>	23, 73, 82, 83
Nouaille	21, 56

P

Palpation probe	
<i>Double ended probe</i>	56
<i>Flap probe</i>	56
<i>Monopolar palpation probe</i>	55
<i>Round probe</i>	56, 75
<i>Round probe graduated</i>	56
Partensky	71
Peanut holder	85
Pignata	20
Porpiglia	6
Prete	59
Puglisi	20

Q

Querleu	33
----------------	----

R

Reinberg	82
Retractor	
<i>Articulated retractor</i>	56
<i>Double retractor</i>	69, 85
<i>Retractor with blades</i>	56

S

Sartori	38
Satinsky	36
Schey	86
Scissors	
<i>Curved</i>	28, 29, 83
<i>Straight</i>	28, 73, 81, 82
Scopinaro	7
Sealing cap	61, 62, 63, 64, 65, 66, 67, 68, 69, 76, 77

Sheath for Tube	27, 41, 49
Sleeve	
<i>for puncture needle</i>	60
<i>for telescope</i>	58
Soubrane	71
Sterilization case	87
Storz	49, 55, 71
Suction irrigation tube	59, 78
Surgical instrument paraffin oil	87
Sutter	49, 55, 71

T

Tension Arm	
<i>Flexible tension arm</i>	57
<i>Instruments holder for arm</i>	57
<i>Operating room table clamp</i>	57
Terris	85
Trocar	
<i>Body trocar</i>	63, 64, 77
<i>Trocar head</i>	62, 64, 65, 66, 68, 76
<i>Magnetic valve for trocar head</i>	62, 64, 65, 66, 76
<i>Silicone valve for trocar head</i>	62, 63, 64, 65, 66, 76, 77
<i>Smooth cannula</i>	62, 64, 65, 66, 68, 76
<i>Threaded cannula</i>	64, 65, 66, 68, 70
<i>Trocar tip</i>	62, 63, 64, 65, 66, 68, 70, 76, 77, 84
<i>Piston valve cannula trocar</i>	67
<i>Reducer sleeve</i>	69
<i>Sealing cap for trocar</i>	62, 63, 64, 65, 66, 67, 68, 69, 76, 77
<i>Trocar holder ring</i>	84
Tube	
<i>Insulated tube</i>	41, 46, 49
<i>Metal tube</i>	27, 41, 49
<i>Non-insulated tube</i>	7, 45, 47, 50, 52

V

Vallancien	16, 50
Valleylab	49, 55, 71

W

Wire pass	
<i>Articulated</i>	60
<i>Retractable</i>	60
<i>Retractable fascial closure</i>	60
Wolf	49, 55, 71

Alphabetical index
Search by name

A

Adson-Brown	Forceps with teeth	83
Aesculap	Bipolar cable	49, 71
	Monopolar cable	55
Allal	Dissector insert	17
Allis	Forceps with teeth	15, 73, 81
	Grasping insert with insulated tube	72, 80
Annibale	Intestinal clamp insert	34

B

Begin	Choledoque clamp	38
	Clamp applicator	38
	Clamp applicator insert	38
	Debakey clamp	38
	Intestinal clamp	38
Belghiti	Bipolar irrigation forceps	71
Berchtold	Bipolar cable	49, 71
Bertrand	Articulated wire pass	60
	Fenestrated forceps	3
	Fenestrated insert	2
Botella	Bipolar forceps triangular jaws	53
	Bipolar insert fenestrated jaws	52
Bovie	Monopolar cable	55
Bowa	Bipolar cable	49, 71
	Monopolar cable	55
Cadière	Fenestrated forceps	75

C

Cau	Needle-holder insert	22
Claw	Forceps with teeth	15
	Grasping insert	14
Conmed	Monopolar cable	55
Crovella	Fenestrated insert	4

D

De Lagausie	Alligator forceps	82
	Dissector	82
	Fenestrated forceps	82
	Straight scissors	82
De Manzini	Fenestrated insert	7
	Non-insulated tube	7
Delaitre	Babcock forceps	11
	Babcock insert	10
	Curved clamp insert	32
	Debakey clamp	33
	Dissector	21
	Dissector insert	17, 18, 20
	Intestinal clamp	35

Delaitre	Knot pusher	25
	Monopolar palpation probe	55
Descottes	Double retractor	69
Desmaizieres	Angled clamp	37
	Curved clamp	37
	Fenestrated forceps	5
	Fenestrated insert	4
	Straight clamp	30
Desplantez	Fenestrated forceps	5
Dessi	Bipolar angled handle	50, 52
Dousset	Bipolar irrigation forceps	71
Drouard	Knot guide scissors insert	25
Dulucq	Debakey clamp	31
	Smooth trocar tip	65
Duval	Fenestrated forceps	9

E

Elhadad	Ergonomic handle	42
Emc	Bipolar cable	49, 71
Erbe	Bipolar cable	49, 71
	Monopolar cable	55

F

Falchero	Guide sleeve for Cholangiography	61
-----------------	----------------------------------	----

G

Gayet	«K» handle, bipolar	50, 52
	Bipolar forceps fenestrated jaws	51, 74
	Bipolar insert fenestrated jaws	50
	Bipolar irrigation forceps	71
	Fenestrated forceps	3

H

Henry	blunt tip trocar	84
	Hook	84
	Micro fenestrated forceps	84
	Micro forceps	84
	Micro palpation probe	84
	Micro scissors	84
	Trocar holder ring	84
Hüscher	Round jaws insert	8

I

Iannelli	Knot pusher	75
-----------------	-------------	----

J

Johann	Bipolar insert fenestrated jaws	48
	Fenestrated forceps	3
	Fenestrated insert	2

L

Lamidey	Bipolar cable	49, 71
	Monopolar cable	55

M

Manhès	Alligator forceps	13
	Alligator insert	12
	Bipolar forceps spatula jaws	53
	Cobra insert	14
	Curette forceps	70
	Curette insert	70
	Forceps with teeth	15
	Grasping insert	14
	Retractable monopolar electrode	55
	Straight scissors	28
	Tiger insert	14

Martin	Bipolar cable	49, 71
	Monopolar cable	55

Massard	Enclume holder insert	39
----------------	-----------------------	----

Mauras	Guide for guide sleeve	61
	Guide sleeve for Cholelscopy	61

Mintz	Sharp trocar for punction needle	60
	Sleeve for punction needle	60
	Smooth trocar for punction needle	60

Montupet	Babcock forceps	81
	Bipolar forceps spatula jaws	53
	Body trocar with smooth cannula	63, 77
	Body trocar with threaded cannula	63, 64, 77
	Fenestrated forceps	3, 81
	Hook	54, 78
	Needle-holder, tungsten straight jaws	82
	Piston valve cannula trocar with stopcock	67
	Pyramidal trocar tip	63, 64, 77
	Straight scissors	28, 81

Morino	Anvil circular suturing holder insert	39
	Retractable wire pass	60

Mosnier	Double retractor	69
	Flexible tension arm	57
	Instruments holder for arm	57

Mouiel	Bipolar forceps fenestrated jaws	51
	Bipolar insert fenestrated jaws	50
	Needle-holder, automatic titanium jaws	23
	Needle-holder, straight jaws	24

N

Nouaille	Articulated retractor	56
	Dissector	21

P

Partensky	Bipolar irrigation forceps	71
------------------	----------------------------	----

Pignata	Dissector insert	20
----------------	------------------	----

Porpiglia	Fenestrated and flat insert	6
------------------	-----------------------------	---

Prete	Eyes cannula	59
--------------	--------------	----

Puglisi	Dissector insert	20
----------------	------------------	----

Q

Querleu	Debakey clamp	33
----------------	---------------	----

R

Reinberg	Needle-holder, tungsten straight jaws	82
-----------------	---------------------------------------	----

S

Sartori	Debakey clamp	38
----------------	---------------	----

Satinsky	Angled clamp	36
-----------------	--------------	----

Scheye	Axial handle	86
---------------	--------------	----

	Curette insert for biopsy	86
--	---------------------------	----

Scopinaro	Fenestrated insert	7
------------------	--------------------	---

	Non-insulated tube	7
--	--------------------	---

Soubrane	Bipolar irrigation forceps	71
-----------------	----------------------------	----

Storz	Bipolar cable	49, 71
--------------	---------------	--------

	Monopolar cable	55
--	-----------------	----

Sutter	Bipolar cable	49, 71
---------------	---------------	--------

	Monopolar cable	55
--	-----------------	----

T

Terris	Double retractor	85
---------------	------------------	----

	Elevator	85
--	----------	----

	Micro nerve eye suction tube	85
--	------------------------------	----

	Micro suction tube elevator	85
--	-----------------------------	----

	Peanut holder	85
--	---------------	----

V

Vallancien	Bipolar insert fenestrated jaws	50
-------------------	---------------------------------	----

	Fenestrated insert	16
--	--------------------	----

Valleylab	Bipolar cable	49, 71
------------------	---------------	--------

	Monopolar cable	55
--	-----------------	----

W

Wolf	Bipolar cable	49, 71
-------------	---------------	--------

	Monopolar cable	55
--	-----------------	----

Manufacturers :



Integra MicroFrance SAS (France)
Le Pavillon ■ 03160 Saint Aubin le Monial ■ France



Integra York PA, Inc
589 Davies Drive
York, PA 17402 ■ USA



Integra LifeSciences Sciences (France) SAS
Immeuble Séquoïa 2
97 Allée Alexandre Borodine
Parc Technologique de la Porte des Alpes
69800 Saint Priest ■ France

Tél. : +33 (0)4 37 47 59 00 i Fax : +33 (0)4 37 47 59 30



HEMODIA SAS
85, rue du Chêne Vert
31670 LABEGE ■ France



Swann Morton Ltd
Penn Works ■ Owlerton Green ■ Sheffield
South Yorkshire S6 2BJ ■ Royaume Uni

Manufacturers with CE class I products only :



Chemische Fabrik Dr. Weigert GmbH & Co.
Mühlenhagen
D-20539 Hamburg ■ Allemagne

Availability of these products might vary from a given country or region to another, as a result of specific local regulatory approval or clearance requirements for sale in such country or region.

- Consult product labels and inserts for any indications, contraindications, hazards, warnings, precautions, and instructions for use.
- Non contractual document. The manufacturer reserves the right, without prior notice, to modify the products in order to improve their quality.
- Warning: Applicable laws restrict these products to sale by or on the order of a physician.

Additional information for EMEA Customers only :

Products mentioned in this document are CE class I, IIa or IIb devices. Contact Integra should you need any additional information on devices classification. All the medical devices mentioned on this document are CE marked according to European council directive 93/42/EEC on medical devices and its relatives.

References that are not medical devices are identified with the indication "NOT A MEDICAL DEVICE".

Products marked with the symbol [®] are distributed by Integra MicroFrance SAS (France)

Date of last révision : 03/2018

For more information, please contact customer service :

Europe, Middle-East, Africa

International : +33 (0) 437 47 59 50 ■ +33 (0) 437 47 59 25 (Fax) ■ csmea@integralife.com
France : +33 (0) 437 47 59 10 ■ +33 (0) 437 47 59 29 (Fax) ■ custservfrance@integralife.com
United Kingdom : +44 (0) 1264 345 780 ■ +44 (0) 1264 363 782 (Fax) ■ custsvckuk@integralife.com
Germany : +49 (0) 2102 5535 6200 ■ +49 (0) 2102 5536 636 (Fax) ■ custsvcgermany@integralife.com
Benelux : +32 (0)2 257 4130 ■ +32 (0)2 253 2466 (Fax) ■ custsvcbenelux@integralife.com
Italy : +39 (0)2 577 8921 ■ +39 (0)2 575 113 71 (Fax) ■ custsvcitaly@integralife.com
integralife.eu/contact

Integra and the Integra logo are registered trademarks of Integra LifeSciences Corporation or its subsidiaries in the United States and/or other countries.

MicroFrance is a trademark of Integra LifeSciences Corporation or its subsidiaries.

All other trademarks and product names are the property of their respective owners.

© 2018 Integra LifeSciences Corporation. All rights reserved.

0328572-2-EN

DOCUMENT FOR USE IN EUROPE, MIDDLE-EAST AND AFRICA ONLY.